

User Manual



Balance

Van Raam
Guldenweg 23
7051 HT Varsseveld, The Netherlands

☎ +31 (0)315 – 25 73 70

✉ info@vanraam.com

🌐 www.vanraam.com

Version 25.04



Table of contents

Manufacturer contact details	3
Conformity Europe (CE)	3
Conformity UK (UKCA)	3
Introduction.....	4
Delivery.....	4
Indication.....	5
Intended usage	5
Safety measures.....	6
Adjustment of the bicycle.....	9
Before the first use.....	11
Silent electrical system	14
Van Raam e-bike app.....	28
Accessories.....	29
Technical specifications	31
Cleaning and maintenance by owner	32
Repairs and maintenance to be done by dealer	34
Adjustments to be done by dealer.....	35
Disposal	36
Handover/sale to a new owner	36
Guarantee	37
Frame number.....	38
Maintenance recommendation	39
Service plan.....	41
Delivery and service form.....	43

Manufacturer contact details

Van Raam Mobility B.V.

Guldenweg 23

7051 HT Varsseveld, The Netherlands

☎ +31 (0)315 – 25 73 70

✉ info@vanraam.com

🌐 www.vanraam.com

Conformity Europe (CE)

Van Raam Mobility B.V. declares as manufacturer that the Balance bicycle, as described in this user manual, have been produced in accordance with regulation (EU) 2017/745, risk class 1. The tricycles fitted with the Electro system Silent also comply with the 2006/42/EC directive including the EMC directive 2014/30/EU and the NEN-EN 15194:2017 Bicycles - Electrically supported bicycles - EPAC Bicycles - part 4.2 Electrical requirements. The signed declaration of compliance can be found on the Van Raam website.

Conformity UK (UKCA)

Van Raam Mobility B.V. as manufacturer declares that the Balance, as described in this user manual, is manufactured in accordance with the "Essential Requirements of Medical Devices Regulation 2002" (UK MDR 2002 Class 1 Medical Devices). The Balance supplied with the Silent electrical system also complies with the "Machinery (Safety) Directive SI 2008/1597" including the applicable parts of "Electro Magnetic Compatibility Regulations SI 2016/1091" and the NEN-EN 15194:2017 Bicycles - Electric support bicycles - EPAC Bicycles - part 4.2 Electrical requirements. The Balance is provided with UKCA label according to "EU Exit Regulations 2020/1478". The signed declaration of conformity can be found on the Van Raam website.

Introduction

This user manual provides important and necessary information about the use of your bicycle.

We request that you read this manual thoroughly before using the bicycle. Always follow the instructions as provided in this user manual and keep the manual carefully. The most current version of the user manual can be found on the product page of the bicycle on the website www.vanraam.com. Disclaimer: images may differ from the bike you have received.

For children and people with limited mental perception, all safety and handling aspects of this manual must be made understandable by a responsible supervising person.



READ CAREFULLY

Delivery

Your delivery should include the following:

- Bicycle with packaging
- User manual(s)
- Possible chargers (depending on options)
- (Spare) keys

Check the delivery immediately after receiving it. In case of damage or incomplete delivery we ask you to contact your dealer immediately. Upon delivery you should fill out the form "Form service, maintenance, modifications and warranty claims" in the back of this manual.

Indication

The Balance can be used by people that have difficulty getting on and off the bicycle, people with neck, shoulder and wrist complaints, and persons with slight balancing problems.

Intended usage

The bicycle is designed for normal use on level and solid ground. The usual bicycle caution should always be taken into consideration. In general, bicycle caution should always be observed when using the bicycle. Moreover, the safety instructions as described in this manual should be explicitly followed. Local traffic laws and regulations should also be observed.

The bicycle is meant for one person. The driver should be independently mobile and may not have any serious visual or other impairments, which prevent responsible participation in traffic. The maximum user weight and luggage load (to be found in the chapter '**Technical Specifications**') may not be exceeded.

The manufacturer is not responsible for any damage or injury caused as a result of or during the course of any other type of use.

Safety measures

- Take immediate action if any part is loose while using the bicycle, if slack is detected or if you hear a strange noise. If you cannot solve the problem yourself, please contact your Van Raam dealer. Pay particular attention to the wheels, handlebars and seat.
- Only use the bicycle on a **solid and level surface**.
- Make sure that no dangerous speed develops on descents. Brake on time and cycle at a moderate speed.
- Be careful not to get baggy pants or loose-fitting clothing caught in the chain, wheels, pedals and other rotating/moving parts.
- Do not use a high pressure or steam cleaner for cleaning.
- Lock the bicycle at all times if you leave the bike unattended.
- During pregnancy, extra caution is required because of an increased risk of injury.
- Do not put the bicycle in direct sunlight: the temperature of some parts can exceed 41°C. Contact with the skin may cause skin sensitisation.
- If pedal assistance is available on the bicycle: practice with the starting aid. When using the bicycle, make sure that the starting aid is not unintentionally activated.
- If the bicycle is equipped with a front-wheel motor, be especially alert to loose gravel/sand on the road surface in curves due to skid danger.
- If a charger is supplied with the bicycle, also read the information under the heading "Charger Safety Precautions" in the **"Electro system Silent"** chapter.

Tips for safe biking

Make sure you have properly adjusted the bike to the dimensions of the rider, then you can use the bike safely and comfortably.

Important safety points for the rider

- Ride very carefully on the first ride.
- Keep your hands on the handlebars and feet on the pedals while riding.
- Test the driving behaviour of the bicycle at an appropriate speed on an uneven surface. This way you learn to react better to unexpected movements of the bicycle and the handlebars during use.
- Always drive perpendicularly and at low speed off the curb or speed bump.
- Small obstacles must be ridden over at an appropriate speed.
- Obstacles higher than five centimetres should be avoided.
- One of the brake levers operates the brake on the front wheel. Extra caution is required here, because the front wheel can lock if the brakes are pulled too strongly. Practice with phased braking.

Check before every ride

Contact your dealer and do not use the bicycle if you notice irregularities during the check!

- Check that the brakes are working correctly. The brakes should work, and you should feel pressure on the brake lever.
- Make sure there is enough air in the tires. The tires may be inflated to the maximum pressure indicated on the side of the tire. Tip for extra comfort: You do not have to inflate the front wheel to the maximum pressure, but make sure you always stay above the minimum specified pressure.
- Check that the lights are working correctly. See chapter '**Before use**' for the correct setting of the lighting.
- Check that the seat and handlebars are secure. See chapter '**Adjusting the bicycle**' for the correct adjustment of the seat and handlebars.
- Make sure the battery is sufficiently charged (optional).

As with all mechanical parts, the bicycle is subject to wear and tear and high loads. If a component fails, it can lead to very dangerous situations and to damage or injury to the bicycle user. Any cracks, scratches or change of colour in heavily loaded parts of a component is an indication that the part must be replaced.

Load

The maximum load should not be exceeded. See the information in the technical data table in the '**Technical Specifications**' section of the user manual. By permitted load we mean the total load, including the load on the luggage rack.

Make sure that the permitted load on the luggage rack is not exceeded. (**maximum** 23 kg). No persons may be transported on the luggage rack without an approved child seat.

Damaged or worn-out parts

The replacement and repair of parts (frame, forks, light, brakes, drive mechanism and the handlebars) should **always** be performed by an authorized dealer. If not, the guarantee ceases to be valid, and you will be personally responsible in the event of possible damage.



Specific safety parts should **always** be replaced by new parts!

Adjustment of the bicycle

Before using the bicycle, adjust it to the measurements of the cyclist. This is of great importance, especially the saddle and the handlebars.



If an optimal adjustment of the bicycle, as defined in the instructions, is not possible, you can contact your dealer for a fitting solution.

The brakes are correctly adjusted and should only be adjusted by the dealer during periodic maintenance.



Take care that fingers and limbs do not get trapped while adjusting the bicycle.

Saddle height

When the cyclist is sitting on the bicycle and can put a foot on the pedal in the lowest position, the saddle height is correct. Adjust the saddle height in such a way that the leg is stretched but relaxed in that position.

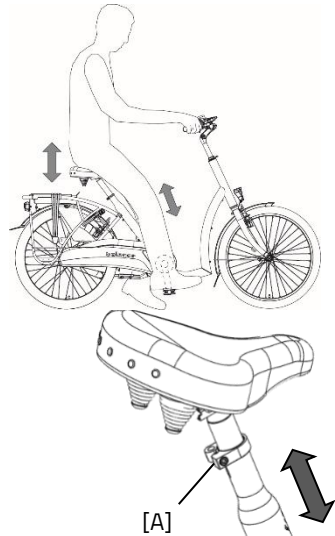

To adjust the saddle:

1. Loosen the screw [A].
2. Slide the saddle to the correct height.
3. Tighten the screw.



Do **not** pull out the saddle pin **further** than the mark. The tube will not go into the shank deep enough and will risk breaking off, which can lead to serious injuries.



Handlebars height

The height of the handlebars affects the comfort of the ride. It determines the pressure on the hands and the position of the back. You decide the most comfortable position yourself with some practice.

To adjust the handlebars:

1. Slightly loosen the screw by using an Allen key.
2. Slide the handlebars to the correct height and tighten the screw very firmly again.

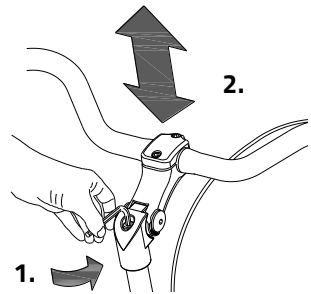

Do **not** pull out the handlebars **further** than the mark. Otherwise, the tube will not be deep enough in the shaft and will risk breaking off, which can lead to serious injuries.



Position handlebars

You can tilt the handlebars. This influences the distance from the handlebars to the upper body. Determine your own most comfortable position by using the bike.

To tilt the handlebars:

1. Slightly loosen the screws [A] and [B] with an Allen key.
2. Put the handlebars in the desired position and then tighten the screws considerably.
3. Slightly loosen screw [C] with an Allen key, put the handlebars in the correct (horizontal) position and then tighten the screw again.

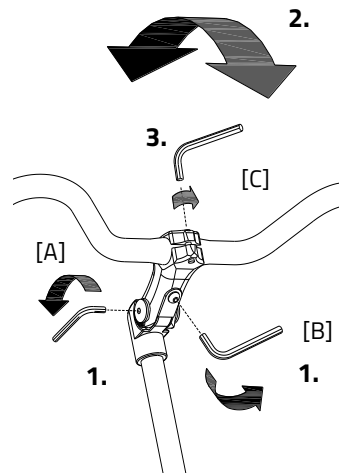

Before the first use

Lighting

Normally, the lighting on your bike can be operated manually and set to different modes. However, if your bike is equipped with the Silent Elektro system, your lighting will automatically turn off when the electric system is activated. The controls of both the manually operated and centrally operated lighting is explained below.

Manually operated headlight

The headlight has a button with three different modes: ON – ON [50%] – OFF.

Adjust the angle of the headlight to its correct position, when the centre of the light beam is about 10 metres in front of the bicycle.

The headlight is powered by batteries. When the batteries are nearly empty, the LED light in the button of the headlight will turn red. Follow the steps to change the batteries of the headlight.

1. Open the headlight by pushing down the tab on the housing and simultaneously pulling the front of the light outward like shown.
2. Change the two alkaline batteries (2x AA).
3. Put the light back together by first pushing the top of the light back into the housing and then pushing the bottom of the light back over the tab of the housing.

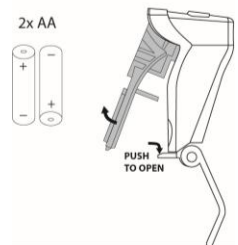
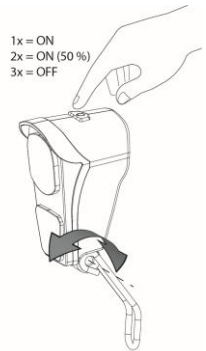

You can only operate the light while your bike is standing still to avoid dangerous situations and to avoid the chance of entrapment.

Manually operated rear light

The rear light has three options which you can choose by pressing the button repeatedly: **On-Auto-Off**.

The setting is as follows:

Press 1x: light is on

Press 2x: lighting is automatic

Press 3x: light is off

With the "On" or "Off" mode, the rear light can be manually switched on and off.

With the "Automatic" mode the rear light automatically turns on and off with the help of light and movement sensors. When the bicycle stands still for a while, the light will automatically turn off.

The rear light works on batteries. When the batteries are almost empty, a red LED light on the top starts flashing. To replace the batteries, follow the next steps.

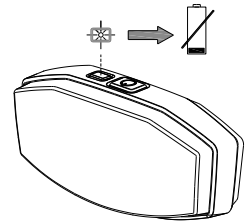
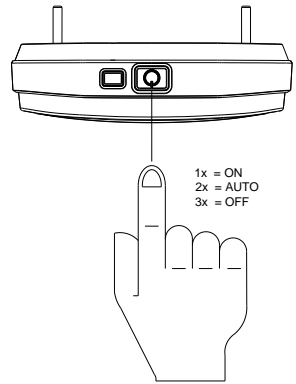

1. Dismantle the cover of the holder by pressing in the lip at the bottom of the light.

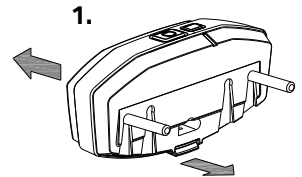

2. Replace the alkaline batteries. (1,5 V - 1500 mA) and assemble the cover.

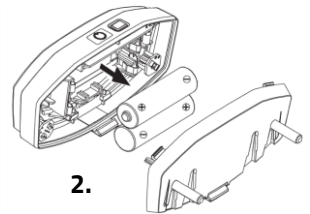

Batteries cause environmental pollution. Follow the local regulations during disposal.

Centrally Operated Lighting

The bike has been equipped with centrally operated lighting, with the lighting being connected to the electric system.

The lighting will turn on automatically when the electric system is activated.

Adjust the angle of the headlight, so that the centre of the light beam is aimed about ten metres in front of the bike.

You can manually turn the lighting on and off by briefly pushing the on/off button on the display. When the electric system is turned off, the lighting will turn off automatically.

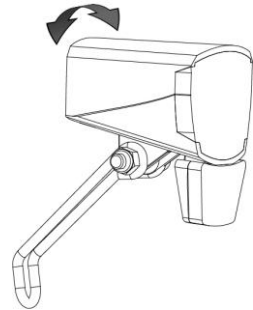

Make sure there is always a battery on the bike when you are cycling after dark!

Once the battery is nearly empty, the motor will no longer provide pedal support power assistance while cycling. The lighting will still be powered by leftover power.

Gears

Standard the bicycle has eight gears. The gear is operated by turning the grip.

Do not use the pedals when turning the grip.

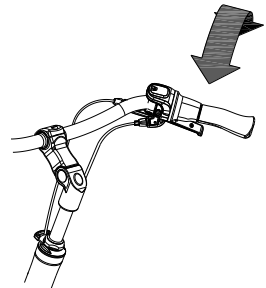

Before you start using your bike, take notice of the safety measures section and make sure you understand them all.

Silent electrical system

Item number: -2195

The Silent electric system is the pedal assist system of Van Raam and consists of 5 components: display, button unit, battery, motor and bottom bracket. How the first 3 parts are used is explained in this user manual.

Operation of the display

The display provides you with cycling information, which will be explained in more detail later. The display is mounted onto the handlebars by means of a bracket. The display cannot and does not have to be removed when leaving the bike.

(1) On/off

This button switches the electrical system on.

(2) Bicycle lights

The lights on the bicycle switch on automatically when the electrical system is switched on. By pressing this button briefly, the lights can be switched off (and on).

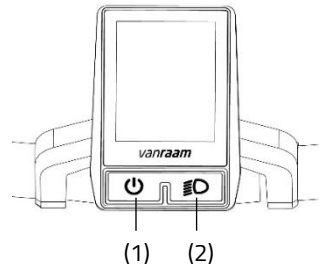

Operation of the button unit

The button unit is mounted next to the handlebar grip. You use the button unit to operate the electrical system.



The button unit can be mounted on the other side of the handlebars by your dealer.

(3) Mode

By pressing this button briefly, you can switch between the different Screen modes.

(4) Plus - Increase pedal support power assistance

(5) Minus - Reduce pedal support power assistance

(6) starting aid

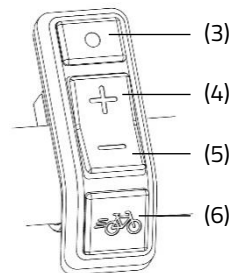

Information screen

After the electrical system is powered up, the information screen is displayed. This screen displays real-time cycling information.



The information screen will only work if you have switched on the electrical system.

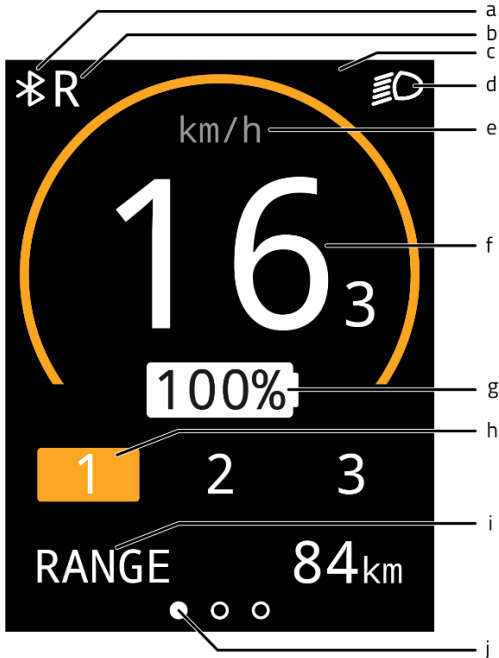

- (a) Bluetooth connection
- (b) Reverse function of (thumb) throttle activated
- (c) Notification field
- (d) Bicycle lights
- (e) Speed indicator
- (f) Speed
- (g) Battery charge percentage
- (h) Assistance mode
- (i) Screen modes
- (j) Screen mode orientation bar

Screen modes

The screen mode (i) can be set by using the mode button (3) You can switch between the following 3 screen modes while cycling.

1. Radius of action [RANGE] (default display)

This is the number of kilometres that can still be cycled with the remaining battery capacity in the active assistance mode.



The range is assistance mode dependent and is an estimate, so the actual range may differ from the estimate. The range is influenced by factors such as battery capacity, level of assistance, tire pressure, riding speed, rider's weight, load, and environment.

2. Trip distance [TRIP]

This is the distance travelled since the trip odometer was last reset. By holding down the mode button for one second, the trip odometer can be reset to 0.



3. Total distance [TOTAL]

This is the total distance travelled by the bicycle when the electrical system has been switched on.



Settings screen





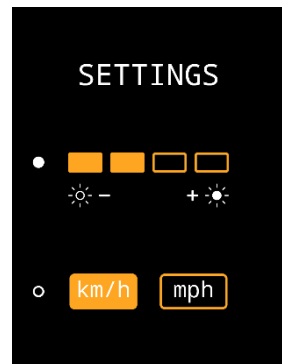

In the settings screen, the brightness of the display and the units of distance and speed can be changed.

To access the settings screen, the mode button (3) and the plus button (4) should be pressed down simultaneously for one second. Using the mode button (3), you can switch between the settings. The plus and minus buttons (4,5) are used to adjust the setting. To exit the setting screen, press and hold the mode button (3) for one second.



Notifications

Several symbols can be displayed in the information screen. The symbols are explained below. More information on the notifications can be found in the chapter **"Possible Faults"**.

-  The bicycle lights are activated
-  A Bluetooth connection is active
-  No communications with the battery
-  Reverse function of (thumb) throttle is activated
-  The temperature of the controller is too high
-  Voltage is too high
-  Fault

Pedal support power assistance

The Silent electrical system provides assistance while cycling.

Starting aid

With the starting aid, pedal assistance is activated up to a speed of 6 km/h, without having to pedal yourself. To do this, press and hold down the starting aid button (6). If the button is pressed again, the function is reactivated.

If you press the starting aid button while cycling, you will get a "boost". This boost will have the same maximum speed as the bike. The activated pedal assistance mode determines the degree of assistance of the starting aid and the "boost".

The starting aid button can be used for:

- Extra assistance when starting off (starting aid).
- Extra assistance when cycling uphill (boost).

Assistance settings

The pedal assistance level can be set using assistance settings 1, 2 and 3. The assistance settings can be changed while cycling.

1. Low level of assistance, maximum range.

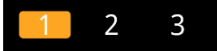

2. Average support, average range.



3. Maximum support, low range.

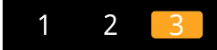

Reverse pedalling

The reverse function is activated by pedalling backwards from a stationary position. After a few turns of the wheel, the motor is activated, and the bicycle will reverse at the speed of 3 km/h for as long as it is pedalled backwards.



Do not let the electric motor's sudden behaviour take you by surprise. For example, if you wait at the traffic lights and pedal backwards just for fun, the reverse function will be activated, and the bike will start riding backwards!

Support modes

A support mode is a set of settings which sets the level of assistance. By loading a different mode, the level of assistance for all assistance modes can be adjusted. Modes can be changed by the dealer or through the Van Raam app.

Charging the battery

Follow these steps to remove and charge the bicycle battery:

1. Unlock the battery by turning the key a quarter.
2. Pull the handle forward.
3. Take the battery pack from the holder.
4. Take the battery inside. **First**, insert the charger's connector into the battery's charging port.
5. **Then** plug the charger into the wall socket. A green LED on the battery will start blinking, and a red LED on the charger will light up to indicate that charging is in progress.



Please note! If there is no proper contact between the battery and the charger, the green LED on the charger will light up (standby mode). This may indicate insufficient connection, so unplug the charger and clean the connector with a dry cloth.

6. Depending on the battery level, the charging time is about 2,5 hours with a 13,6 Ah/36 V battery.
7. Once the battery is fully charged, the green LED will be solid. **First**, unplug the charger from the wall socket.
8. **Then** remove the charger's connector from the battery.

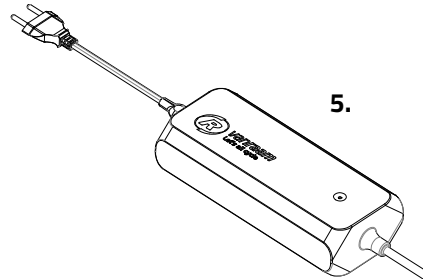
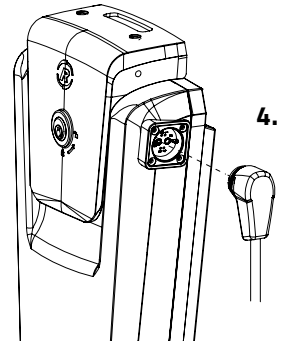
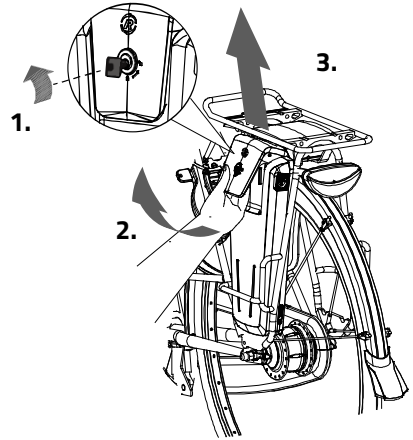

9. Put the battery back in the holder of the cycle. Slide it behind bar [A] and press it firmly on strip [B].
10. Pull the handle backwards and push the top of the battery to connect as shown in the drawing and close the lock.
11. Push the handle forward and close the lock.

It is also possible to charge the battery while it is still in the holder.



Do not wait until the battery is completely empty. It is better to recharge the battery interim.

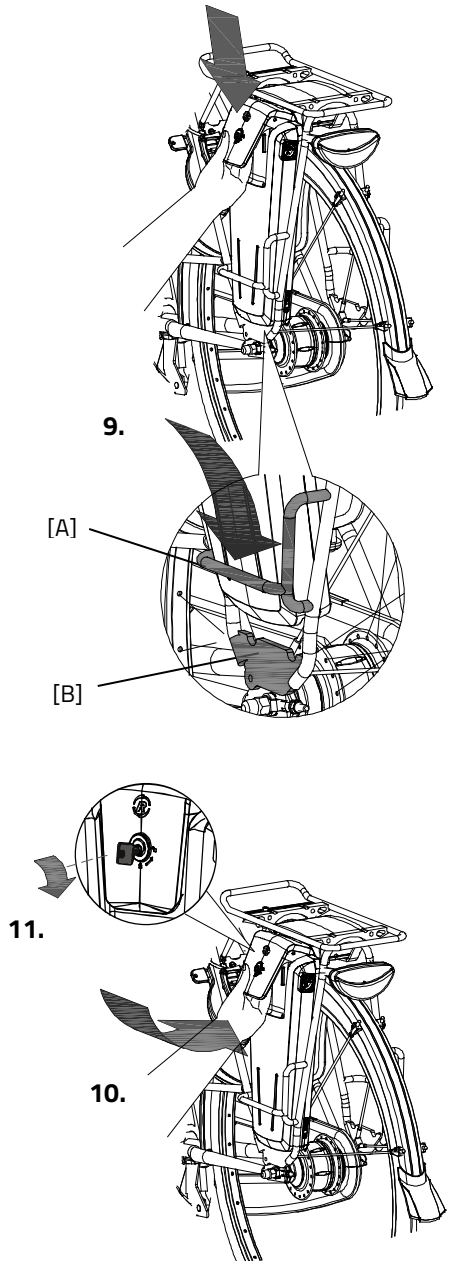



When the system is not used, it will automatically turn off after a certain time.



Always turn off the electric system before getting on and off the bike, and when you are walking while holding the bike.



Make sure that the switch under the luggage carrier is always pressed toward the side where the battery is located. Note that with some models the battery switch has a middle (neutral) position as well. That means the battery is switched off.

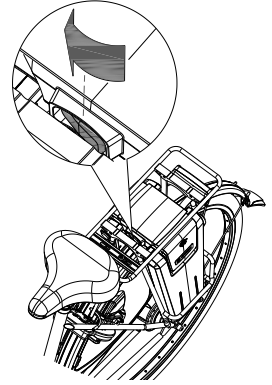

Charger indicator light

The status of the charger is indicated by the coloured indicator light.

- If the indicator light is green, the charger is in standby mode, or the battery is full.
- If the indicator light is red, then the charger is charging the battery.
- ⊘ If the indicator light is flashing red, the charger is in fault mode.

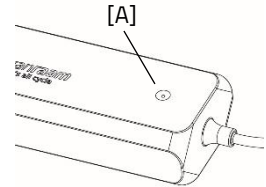

Caution! Unplug the charger from the power outlet.



Only use the charger when the ambient temperature is between 0 °C and 35 °C.



It is better for the battery to be charged periodically instead of waiting until it is completely empty.

Battery indicator lights

On the battery pack there is an LED indicator to check the battery charge status. The battery charge status can be read by briefly pressing the on/off button [A]. While the battery is being charged, the indicator shows the charging progress:

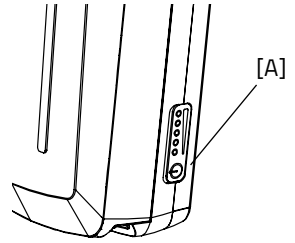

The battery is fully charged. When the battery is used, the number of green lamps will decrease.



If two green lamps are lit, the battery is 50% charged.



If only the left LED remains green, the battery is almost empty and needs to be recharged or replaced with a charged battery.



If the left LED starts blinking green, the battery is empty and the motor will not support cycling for much longer. However, the switchable lighting will still work after that.



Never put the bike away with an empty battery.



Check the battery charge monthly during the winter and recharge it if fewer than three LEDs are lit.

Charger:

LED indication	Status
Green	Standby
Red	Charging
Green	Battery full
Red, blinking	Safety: Polarity inversion; Short; Over temperature; Over power; Over voltage

Backup battery (optional)

The bike can be supplied with a second battery. Once the connected battery is empty, you can switch to the second battery.

To activate the second battery, turn the switch under the luggage carrier to the side of the second battery.

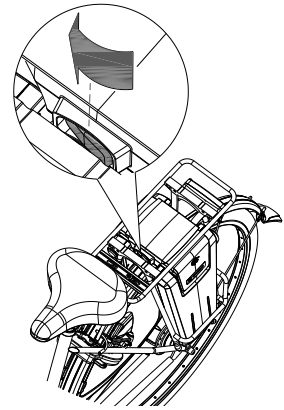

Direction Indicator

The bike can be equipped with a direction indicator. To operate the direction indicators, press switch [A] on the handlebar to the left or right. When the direction indicator is active, a clicking sound can be heard. To deactivate the direction indicator, you need to set the button to the middle position. The direction indicator is powered by the battery of the Silent Electric System.

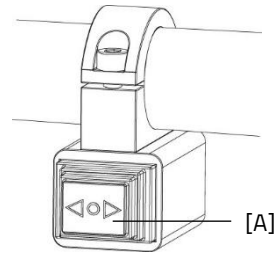

Please note that the turn signal can only be activated when the bicycle's lighting is turned on.

Deep sleep battery mode

When the battery is almost empty and has not been used for a week, the battery will go into a "deep sleep mode". In this mode, the battery uses as little energy as possible, which extends the battery life.

When "deep sleep mode" is activated, the battery cannot be used. By pressing the on/off button [A] on the battery, the battery will be released from 'deep sleep mode' and can be used again. It is advisable to charge the battery before using it.

Charging and maintenance of the battery pack

Important safety warning:



Completely drain the battery during the first use. The battery will then make optimal use of its capacity. It is not necessary to drain the battery in one go; this can also be spread over several rides. After draining, fully charge the battery. The battery can then be used as needed.

- To ensure the battery's optimal condition and capacity, we recommend charging it indoors at room temperature.
- Never put the bicycle away with an empty battery. We recommend charging the battery as soon as possible when it is empty. The best storage charging level for the battery is when the charge display shows three to five LED lights.
- In winter, check the battery charge every other month, recharge it if less than three LEDs light up.
- Preferably store and use the battery between 5 °C and 20 °C, avoid higher and lower temperatures.
- Do not charge the battery in direct sunlight and make sure that the battery is not charged at a temperature lower than 5 °C.
- Only use the charger in dry indoor areas, the charger is not allowed to get wet.
- Only use the supplied Van Raam battery and charger.
- The housing of the battery and the charger must not be opened. In case of any problems, please consult your dealer.
- A Van Raam battery is not allowed nor is it possible to recondition the battery due to safety reasons and incorrect functioning of the electrical system.
- Do not drop the battery as this can cause external and internal damage.
- If the bicycle malfunctions, the battery must be disconnected from the bicycle.



Keep in mind that the bike provides less assistance at lower temperatures (0 °C and below) and that the battery will drain more quickly. It also takes longer to charge at low temperatures.



Every battery drains over time. This process is called 'self-discharge'. A battery that is empty and not charged can undergo a deep discharge caused by self-discharge and become faulty as a result. The warranty is voided in the case of a deep discharge.



Keep in mind that every battery wears out over time. The wear and tear process of the battery is inevitable and depends on several factors such as use, the number of times to fully discharged and charged and the ambient temperature. Even if the battery is not used, its capacity will decrease. A worn-out battery can be used, but keep in mind that the range will be reduced.

Possible faults

- The system cannot be switched on:
 1. Check that the battery is attached properly.
 2. Check the status of the battery. If it is empty, charge the battery.
 3. If the above does not provide a solution, please contact your dealer.
- If a red LED flashes on the charger, unplug the charger from the power outlet and stop using the charger and battery. In this case, contact your dealer.

Faults table

Fault symbol/ code	Description	Consequence/ course of action
All assistance modes are flashing	Temperature controller too high	System does provide assistance, motor power is reduced.
Thermometer (symbol) + all assistance modes are flashing.	Temperature controller too high	System does not provide assistance, let the controller cool down.
Battery with cross (symbol) + all assistance modes are flashing	No communications with the battery	System does provide assistance. Contact your dealer.
Lightning bolt (symbol) + assistance settings are turned off	Voltage too high	System does not provide assistance, voltage drops automatically when cycling speed is slower than maximum assistance speed.
Exclamation mark (symbol) Exclamation mark (symbol)	Voltage too low	System does not provide assistance, check the connection between controller and battery. Check how full the battery is.
	Controller communication error	System does not provide assistance. Contact your dealer.
Active assistance mode is flashing	Electrical current too high	System does not provide assistance. Contact your dealer.
Active assistance mode is flashing	Motor sensor fault	System does provide assistance. Contact your dealer.
All assistance settings are turned off.	The battery is almost empty.	Charge the battery

Charging and maintenance of the battery pack

Important safety warning:

Charger safety precautions

- Only charge Van Raam Li-Ion batteries with the supplied charger. Only connect the charger to a suitable wall socket (220–240 Volt AC 50-60 Hz). When the charger is not in use, disconnect it from the power outlet and the power plug from the battery.
- The charger may only be used by persons who have read the information in this manual and are familiar with the correct use of the charger. Keep the charger out of reach of children; they should not play with the charger.
- The charger is designed for use in a dust-free, dry and ventilated environment. Do not expose the battery to water, heat sources and direct sunlight. Keep the charger clean and dry.
- Do not charge batteries that feel hot. The battery may only be charged in places where the temperature is no higher than room temperature. Stop charging if the battery gets hotter than ($> 40\text{ }^{\circ}\text{C}$).

Caution! The charger can become warm during charging $> 50\text{ }^{\circ}\text{C}$. First, carefully feel whether you can pick up the charger, this temperature can cause hypersensitivity or a startled reaction when it comes into contact with the skin.

- Do not use the charger if it is visibly damaged or modified. Do not repair the charger yourself! Please contact Van Raam. You are strictly prohibited from opening the charger yourself!
- Always keep an eye on the charger and battery while charging. When the battery is full, disconnect the power plug from power outlet and remove the power plug from the battery.

Van Raam e-bike app

The Van Raam bicycle app is a free smartphone app that you can use while cycling on your electric Van Raam bicycle.

The Van Raam e-bike app can be downloaded free of charge from the **Google Play Store** or **Apple App Store**.

Apple app store:



Google Play Store:



For more information about the Van Raam e-bike app, you can visit the Van Raam website: www.vanraam.com.

Accessories

Depending on your order, you can use the accessories as described below. Extra accessories are available at your dealer.

Crank shortener

The crank shortener is fitted to the crank, as illustrated. The pedal can then be fitted into the crank shortener at two positions.

With the screw [A] the crank shortener should be aligned with the crank.

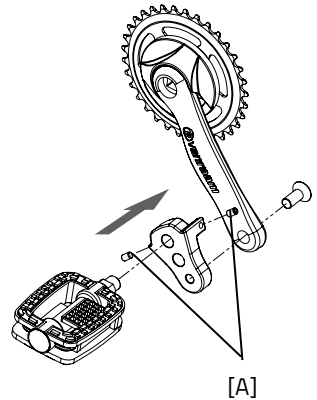

Eccentric crank

The bicycle can be fitted with an eccentric crank on the left and/or right side. The illustration may differ from your crank, because it is custom made.

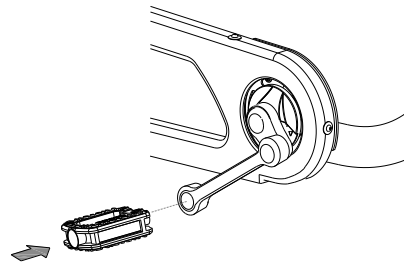

Walking-stick holder

You can take two walking-sticks with you in the stick holder. Place the walking-stick in the holder at the bottom side [A] and then secure the stick in the fastening device [B] at the top side.

Always fasten the walking-stick(s) with the Velcro band.

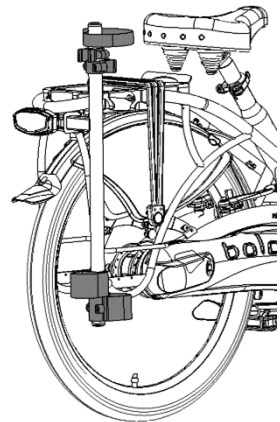

Flashing light system

To use the flashing lights, press the switch [A] to the left or right.

To turn off the indicators, move the switch to the centre position.

The lights work on a battery. To replace the batteries, turn the screw on the cap and take the orange cap [B] away. Then remove the PCB [C] from the holder. You can now replace the battery [D].

This is a 3-volt lithium battery, CR123A



*Batteries cause environmental pollution.
Follow the local regulations during disposal.*

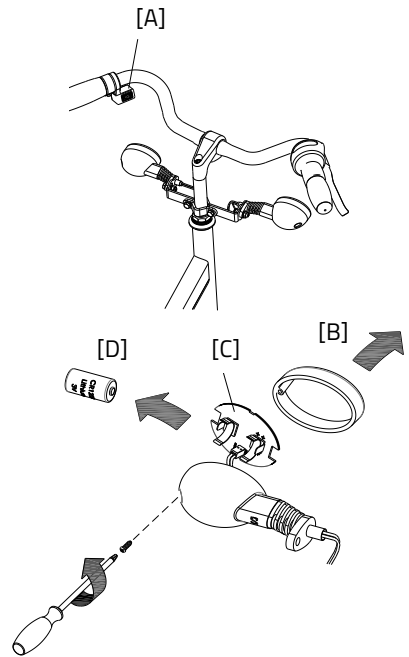

Floating pedal

The floating pedal can be set to different positions. To do this, the hexagon bolt [A] must first be loosened a few turns with an Allen key. The floating pedal can then be adjusted to the desired height. Then re-tighten the bolt.

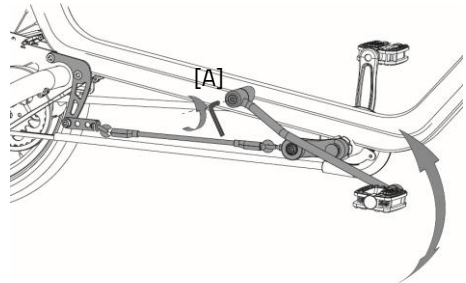

The image may differ from the bicycle.



*When rolling backwards and dismantling the bicycle, the floating pedal can kick back.
Be aware that in this situation, the pedal may come into contact with the leg.*

Technical specifications

Length (cm)	182
Width (cm)	66
Height (cm)	117
Inseam (cm)	67-82, 76-91* , 85-100
Frame height (cm)	42, 51* , 60
Entry height (cm)	22
Front wheel	24"
Back wheel	24"
Weight (kg)	about 26 excluding electric components
Max. load luggage rack (kg)	23
Max. user weight (kg)	120
Brakes, front	hydraulic rim brakes
Brakes, back	hydraulic rim brakes

* Standard

Cleaning and maintenance by owner

Below you can find the instructions for maintenance and adjustments that you can do yourself on a regular basis, which will keep your bicycle in top condition.

Cleaning

The frame of the bicycle can be cleaned with a damp cloth. For areas that are dirtier you can use a mild detergent.

The wheels can be cleaned with a moist brush with plastic hairs (not a wire brush!). The saddle and the grips can be cleaned with mild soap and water.



Do not use a pressure washer or a steam cleaner!

The right lubricant

The chain should be cleaned and maintained at regular intervals (every three months approximately). Only use special chain grease or Teflon spray. This is the only way to make sure that the chain will run smoothly, will stay water resistant and will not rust.

1. Wipe the chain with a cloth.
2. Treat it with grease or spray.
3. Remove any excess lubricant with a rag.

Other parts should **not** be treated with a lubricant.

Inspection of the bicycle

It is recommended that the bicycle has a yearly inspection carried out by the dealer to claim warranty. Please use the form "Form service, maintenance, modifications and warranty claims" in the back of this manual. After 200 kilometres or after a period of two months the bicycle should be inspected.

In the event of technical trouble or faults, the bicycle should be taken to the dealer for repairs **immediately**.

The replacing of safety-related components (especially frame, brakes, lighting, handlebars, front fork and actuation) should be performed by the dealer.

If you still decide you want to replace components yourself, you are responsible for damage or harm due to incorrectly fitted components.

Only use **original** Van Raam spare parts, which you can buy at you dealer. If requested the dealer will make the necessary information on repair and maintenance available.

Repairs and maintenance to be done by dealer

Check the brakes, the rims, lighting, the chain tension and the spokes. Also check the tyre tread depth. This should be at least one millimetre. Worn out tyres or possible faulty parts should be replaced.

Checking the rim

Due to the combined action of the brake and the rims, not only the brake lining but also the condition of the rim is important. For this reason, the rim should be checked at regular intervals, for example when you inflate the tyres. The presence of fine cracks in the spoke punches or deformation of the rim when there is higher air pressure, indicate more serious wear and tear. In that case the rim should be replaced, because it can lead to loss of brake function or even a crack in the rim, which can lead to all kinds of dangerous consequences.

Repairs, maintenance and modifications should only be performed with original Van Raam parts.

Tightening torque

Specific part	Torque
Handlebar stem bolt Balance	21-23 Nm
Handlebar bolts Balance	12-14 Nm
Steering head bearing	Slack-free
Ball bearing front fork	Slack-free
Engine nuts	50 N
Bottom bracket bolts	30 Nm
Crank bolts	37 Nm
Caliper bolts	10 Nm
Wheel bolts	30 Nm
Wheel nuts	37 Nm

Adjustments to be done by dealer

Chain guard removal

To reach the chain for maintenance, the chain guard must be removed. To do this, follow the next steps:

1. Using a Torx screwdriver, remove the 2 screws at the bottom of the transparent chain guard part [A].
2. Pull the transparent chain guard part [A] downward to remove it.
3. Next, remove the Torx screws on the back of the chain guard.
4. After this, the front of the chain guard [B] can be removed by pulling it forwards.

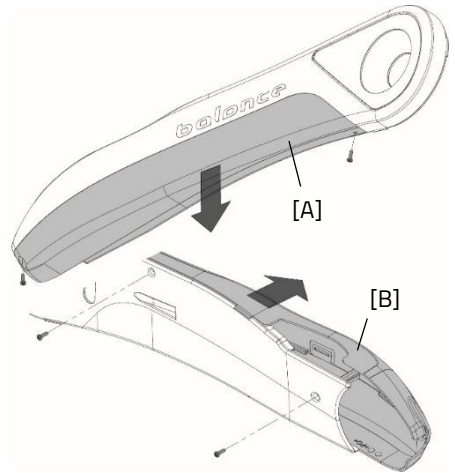

Setting chain tension

The chain should not be too tight. It should be able to have movement. Without force, the chain should be able to move up and down about half a centimetre.

To adjust the chain to the correct tension, follow the next steps:

1. Loosen the chain tensioner wheel nut [A] a few turns. Use a spanner on the back to prevent the nut from turning along with it.
2. Bring the chain to the correct tension by pushing the tensioning wheel [A] up or down.
3. When the chain has the correct tension, retighten the nut.

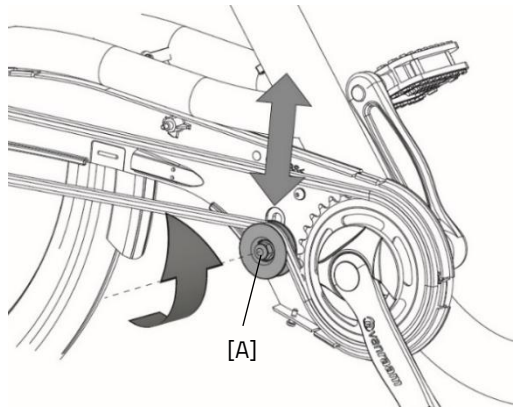

Disposal

Recycling the Bike

In 2018 the WEEE directive 2012/19/EU was updated. As a result, electric two-wheeled bicycles have been included in the WEEE directive since 15 August 2018. If you wish to have your Van Raam bike recycled, please contact your dealer. They are responsible for complying with the recycling obligation. Ask them about the conditions or view the rules regarding recycling in your place of residence/country.

Recycling the Battery

If your battery is defective or if you are no longer using it, you must have it recycled. Please contact your dealer. They are responsible for complying with the recycling obligation. Ask them about the conditions or view the rules regarding recycling in your place of residence/country.

Handover/sale to a new owner

If you transfer the bicycle to a new owner, it is important that you hand over all necessary technical documentation and spare keys, so that the new owner can use the bicycle safely.

Do you use the Van Raam E-Bike App and have you linked your bike to the app? Make sure you disconnect the bike and battery from the app when transferring/selling.

Guarantee

The guarantee is valid for all faults in the product, which are proven to be caused by material or manufacturing error.

We give a guarantee of five years on the frame and the front fork. For all accessories and other parts (except wear parts) we provide a two-year guarantee, as legally regulated. The guarantee only applies for normal use and maintenance of the bicycle, as described in this manual.

Beware!

The guarantee as well as the product liability in general expires if the instructions stated in this manual are not followed. This is also the case if unauthorized maintenance is carried out or if technical changes or additions are made with non-original Van Raam parts without permission of Van Raam. The original CE certification will become nul-and-void if modifications are done by third parties. The absence of the certification can lead to problems in insuring your bike, and for any loss or incurred.

Frame number

The frame number is printed on the sticker. This sticker is located on the frame, see the image below.

Example sticker:



Position of sticker:



On backside of the
saddle tube

Maintenance recommendation

A Van Raam bike often is subject to extensive use and must perform in all weather conditions. By correctly maintaining the bike, the lifecycle can be extended greatly. This maintenance can be done by a Van Raam dealer. In most cases, you can do the monthly and annual inspection yourself.

Maintenance Overview:

What	One-person bike	Multi-person bike	Duration	By whom?
1 st service moment	3 months/300 km	3 months/200 km	15 min	Dealer
2 nd Service moment	6 months/1.000 km	6 months/500 km	15-30 min	Dealer
3 rd Service moment	12 months/2.000 km	12 months/1.000 km	30-90 min	Dealer
Monthly inspection*	Every month	Every month	15 min	User
Annual inspection*	Every 12 months	Every 12 months	60 min	User

* This is advised to extend your bike's lifecycle. You can also have this done by your dealer.

<p>Monthly inspection</p> <p>15 minutes</p> <p>Among them:</p> <ul style="list-style-type: none">• Check and inflate the tyres• Check the chain tension and grease if needed• Tighten bolts/nuts where needed• Check all lights• Check the brakes• Check all rotating parts and grease if needed• Clean the bike	<p>Annual inspection</p> <p>60 minutes</p> <p>Among them:</p> <ul style="list-style-type: none">• Check and touch up the paintwork• Check wheels for damage to rim, tire, spokes, hub and bearings• Check spoke tension and wheel trueness• Check the steering ball joints• Check all lights• Check the saddle clamp• Check the placement of all electric components (E-Bikes only)
---	--

1st Service moment

15-30 minutes

Among them:

- Check tyres and inflate
- Check the spoke tension
- Check the chain tension and grease
- Tighten any bolts and nuts if needed
- Check all brake cables and brake calipers
- Check the gears
- Check and grease all rotating parts
- Check all lights
- Clean the bike

2nd Service moment

30-90 minutes

Among them: All points from service moment 1, and:

- Checking the pedals and bottom bracket
- Checking and lubricating the lock
- Disassembling, assembling, and greasing the steering stem
- Check the steering ball joints
- Run all tests in the dealer tool (E-Bike)

3rd Service moment

60-120 minutes

Among them: All points from service moment 1, 2, and:

- Inspection of the paintwork
- Inspection of the frame/front fork
- Inspection of the seat cushions
- Inspect the functioning and sound of the motor/gear hub
- check reflectors for any damage
- Check all electric components on their placement (E-Bike)
- Run all tests in the dealer tool (E-Bike)

Service plan

1st Service moment

- Yes/No
- Dealer:
- Mechanic:

Date:

Remarks:

.....

.....

.....

.....

2nd Service moment

- Yes/No
- Dealer:
- Mechanic:

Date:

Remarks:

.....

.....

.....

.....

3rd Service moment

- Yes/No
- Dealer:
- Mechanic:

Date:

Remarks:

.....

.....

.....

.....

Annual inspection

Date	Dealer	Mechanic	Remarks

Delivery and service form

Congratulations on your purchase of your Van Raam bicycle. This bike is produced with utmost care. To guarantee the quality as much as possible Van Raam produces the cycles according to the ISO 9001:2015 quality standards. Van Raam has been certified by DNV GL Business Assurance B.V.

You will especially enjoy your Van Raam bike when the bike is adjusted to your specifications and when the instructions in the user manual are followed. Pay special attention on the service intervals who specified in the manual of the bike.

To claim warranty and service you should always fill out this form, at least at delivery and service. This signed form declares that the end user had an instruction on the operation of the bicycle, that the bicycle is adjusted to the specifications of the end user and that the user manual is received.

To be completed upon delivery of the bicycle

Van Raam bicycle type:	
Frame number:	
Key number:	
Supplied to:	
By dealer:	
Location:	
Date:	
Signature bicycle user:	Signature dealer:
If applicable, stamp dealer:	