



User Manual



Easy Sport



Easy Sport Small

Van Raam
Guldenweg 23
7051 HT Varsseveld, The Netherlands

☎ +31 (0)315 – 25 73 70

✉ info@vanraam.com

🌐 www.vanraam.com

Version 24.04



Table of contents

Manufacturer contact details	3
Conformity Europe (CE)	3
Conformity UK (UKCA)	3
Introduction.....	4
Delivery.....	4
Indication.....	4
Intended usage	5
Safety measures.....	6
Adjustment of the tricycle	10
Before use	15
Silent electrical system	19
Silent Electrical System options	30
Van Raam e-bike app.....	32
Options	33
Technical specifications	38
Cleaning and maintenance by owner.....	39
Repair and maintenance by dealer	41
Return point for removal	43
Handover / sale to a new owner	43
Warranty	44
Frame number.....	45
Maintenance recommendation	46
Service plan.....	48
Delivery and service form.....	51

Manufacturer contact details

Van Raam

Guldenweg 23

7051 HT Varsseveld, The Netherlands

☎ +31 (0)315 – 25 73 70

✉ info@vanraam.com

🌐 www.vanraam.com

Conformity Europe (CE)

Van Raam Reha Bikes B.V., as manufacturer, declares that the Easy Sport and Easy Sport Small, as described in this user manual, is manufactured in accordance with Regulation (EU) 2017/745, risk class 1. The Easy Sport and Easy Sport Small supplied with the Silent electrical system also complies with Directive 2006/42/EC including the applicable parts of EMC Directive 2014/30/EU and the NEN-EN 15194:2017 Bicycles - Electric supporting bicycles - EPAC Bicycles - part 4.2 Electrical requirements. The signed declaration of conformity can be found on the Van Raam website.

Conformity UK (UKCA)

Van Raam Reha Bikes B.V. as manufacturer declares that the Easy Sport and Easy Sport Small, as described in this user manual, is manufactured in accordance with the "Essential Requirements of Medical Devices Regulation 2002" (UK MDR 2002 Class 1 Medical Devices). The Easy Sport and Easy Sport Small supplied with the Silent electrical system also complies with the "Machinery (Safety) Directive SI 2008/1597" including the applicable parts of "Electro Magnetic Compatibility Regulations SI 2016/1091" and the NEN-EN 15194:2017 Bicycles - Electric support bicycles - EPAC Bicycles - part 4.2 Electrical requirements. The Easy Sport and Easy Sport Small is provided with UKCA label according to "EU Exit Regulations 2020/1478". The signed declaration of conformity can be found on the Van Raam website.

Introduction

This user manual provides important and necessary information about the use of the Easy Sport and Easy Sport Small. We request that you read this manual thoroughly before using the bicycle.

Always follow the instructions as provided in this user manual and keep the manual carefully. The most current version of the user manual can be found on the product page of the bicycle on the website www.vanraam.com.



READ CAREFULLY

For children and people with limited mental perception, all safety and handling aspects of this manual must be made understandable by a responsible supervising person.

Delivery

Delivery must include the following:

- Bicycle with any packaging
- User manual(s)
- Possible Smart battery including card with 5-digit code (depending on options)
- Possible chargers (depending on options)
- Spare keys

Check the delivery immediately upon receipt. In case of damage or an incomplete delivery, we request that you contact your dealer immediately. On delivery, complete the "delivery and service form" on the back of this user manual with your dealer.

Indication

Children or adults who cannot use bicycles or vehicles due to their disabilities may be able to ride these tricycles. The tricycles can be used by children or adults with a neuromuscular disease (such as congenital brain injury, non-congenital brain injury or muscular dystrophy). This also applies to problems with, for example, coordination, balance disorders and limited natural movement possibilities. If necessary, supervision may be desirable.

Intended usage

The tricycles are designed for normal use on a flat, solid surface. The usual caution for bicycles should always be observed. The safety instructions as described in this manual must also be strictly followed. Also, the local rules for participation in traffic must always be observed.

The bicycle is intended for one person, this user must be independently mobile and must not have any heavy visual or other restrictions that make it impossible to participate in traffic in a responsible manner. The maximum user weight and luggage weight (can be found under the chapter '**Technical specifications**') may not be exceeded.

Any other use, including damage or injury resulting from this, is not the responsibility of the manufacturer.

Safety measures

- Take immediate action if any part is loose while using the bicycle, if slack is detected or if you hear a strange noise. If you cannot solve the problem yourself, please contact your Van Raam dealer. Pay particular attention to the wheels, handlebars and seat.
- Only use the bicycle on a **solid and level surface**.
- It is not recommended to cycle on a slope steeper than 10%, this carries an increased risk.
- It is recommended to drive slowly on slopes.
- If you stopped on a slope, pull away slowly and if necessary, lean forward to prevent the front wheel from losing contact with the road surface.
- Do you roll backwards on a slope? Brake in doses to prevent the front wheel from losing contact with the road surface.
- The following accessories can adversely affect stability on a slope: rollator holder, stick holder, or a loaded shopping basket.
- Make sure that no dangerous speed develops on descents. Brake on time and cycle at a moderate speed.
- Be careful not to get baggy pants or loose-fitting clothing caught in the chain, wheels, pedals and other rotating/moving parts.
- Do not use a high pressure or steam cleaner for cleaning.
- Use the parking brake when you park (and leave) the bike. Also use the parking brake to block the bicycle from pulling away when getting on and off. See chapter **"Before use"** for correct use of the parking brake.
- Lock the tricycle at all times if you leave the bike unattended.
- During pregnancy, extra caution is required because of an increased risk of injury.
- Do not put the bicycle in direct sunlight: the temperature of some parts can exceed 41°C. Contact with the skin may cause skin sensitisation.
- Note: brake discs can become hot during braking. Be careful not to touch the brake discs shortly after a bike ride.
- If pedal assistance is available on the bicycle: practice with the starting aid and the reverse function. When using the bicycle, make sure that the starting aid or the reverse function is not unintentionally activated. For example, if when stopping at a traffic light, the pedals are turned backwards, the reverse function

will be activated and the bicycle will start to reverse. Practice using the reverse and ride away functions. For more information, carefully read the chapter "**Electro system Silent**".

- If a charger is supplied with the bicycle, also read the information under the heading "Charger Safety Precautions" in the "**Electro system Silent**" chapter.



High speeds when cornering and on uneven terrain, or taking a too sharp turn, can lead to **overturning** the tricycle.



Extra attention is required if a child or an adult with limited mental perception uses the bicycle.

Before the child or adult with limited mental perception starts cycling independently for the first time, they must first practice on the bicycle under supervision.

Pay particular attention to the steering behaviour, as this can be a great source of danger. Also explain that the widest part of the bike is behind the rider. Let the rider practice passing some obstacles to get a sense of how wide the bike is.

Children or adults with limited mental perception must **always** be made aware again of the possible dangers when using the tricycle.

- **Never** leave a child alone with the bicycle unattended!
- Have a child **always** wear a bicycle helmet! Make sure the helmet fits correctly.
- Have a child wear noticeable, reflective clothing.
- It is recommended to mount a flag on the bicycle that protrudes above the child.

Tips for safe biking

Make sure you have properly adjusted the bike to the dimensions of the rider, then you can use the bike safely and comfortably.



Riding a tricycle is a completely different experience compared to riding a bicycle with two wheels.

Important safety points for the rider

- Ride very carefully on the first ride.
- Practice especially cornering and braking, because a tricycle can react in the opposite way from what you would expect.
- Keep your hands on the handlebars and feet on the pedals while riding.
- Test the driving behaviour of the tricycle at an appropriate speed on an uneven surface. This way you learn to react better to unexpected movements of the bicycle and the handlebars during use.
- Explore how the tilting movement of the tricycle responds to body position. Hang to the inside of the turn. Take turns at an appropriate speed.
- Small obstacles must be ridden over at an appropriate speed.
- Obstacles higher than five centimetres should be avoided.
- One of the brake levers operates the brake on the front wheel. Extra caution is required here, because the front wheel can lock if the brakes are pulled too strongly. Practice with phased braking.

Check before every ride

Contact your dealer and do not use the bicycle if you notice irregularities during the check!

- Check that the brakes are working correctly. The brakes should work and you should feel pressure on the brake lever.
- Make sure there is enough air in the tires. The tires may be inflated to the maximum pressure indicated on the side of the tire. Tip for extra comfort: You do not have to inflate the front wheel to the maximum pressure, but make sure you always stay above the minimum specified pressure.
- Check that the lights are working correctly. See chapter '**Before use**' for the correct setting of the lighting.

- Check that the seat and handlebars are secure. See chapter '**Adjusting the bicycle**' for the correct adjustment of the seat and handlebars.
- Make sure the battery is sufficiently charged (optional).

As with all mechanical parts, the bicycle is subject to wear and tear and high loads. If a component fails, it can lead to very dangerous situations and to damage or injury to the bicycle user. Any cracks, scratches or change of colour in heavily loaded parts of a component is an indication that the part must be replaced.

Load

The maximum permissible load must not be exceeded. See the information in the table with technical data under the chapter "**Technical specifications**" in the user manual.

Note that a basket full of luggage can significantly affect driving behaviour (especially on slopes). No luggage may be carried on or hanging from the handlebars that restricts bicycle riding.

Damaged or worn parts

The replacement and repair of the parts (frame, front fork, lighting, brakes, drive and handlebar) should **always** be carried out by a dealer. Otherwise, the warranty will be void and the user will be liable for any damage.



Safety related parts must **always** be replaced by new parts!



If there is any doubt about the functioning or the condition of components on the bicycle, for example due to visual damage, slack or strange noises, an authorized Van Raam dealer should always be consulted.

As with all mechanical parts, the bicycle is subject to wear and tear and high loads. If a component fails, it can lead to very dangerous situations and to damage or injury to the bicycle user. Any cracks, scratches or change of colour in heavily loaded parts of a component is an indication that the part must be replaced.

Adjustment of the tricycle

Before you start using the bike, set it to the dimensions of the rider. This is essential, especially for the seat and handlebars.



If an optimal setting is not possible with the described instructions, you can contact your dealer for a suitable solution.

The brakes are correctly adjusted as standard and should only be checked and adjusted by the dealer during regular maintenance.



Make sure that fingers and other limbs do not get caught when adjusting the tricycle.

Easy Sport

Seating position and frame length

By default the bike is fitted with a derailleur. Therefore, the length of the chain does not have to be altered when the length of the bike changes. The range of this mechanism however, is limited. In case more chain length is needed for a correct position of the derailleur, or a larger range is needed, you can re-position the chain tensioners or extend the chain, see "*setting the chain tension*".

A rule of thumb for a correct seating position is as follows. The driver sits on the bike and puts one foot on the pedal that is furthest away from the driver. Now set the seating position to where the leg is stretched, yet still relaxed. The most comfortable seating position however, you have to decide for yourself. The seating position can be changed by altering the frame length. In order to do so. Follow these steps:

1. Use a spanner to loosen up the bolt of the steering rod [A].
2. Use an hex key to loosen up the two bolts of the frame clips [B and C].
3. Move the front of the frame and set it to the desired length. **Caution!** The frame may not be extended further than the marking on the inner tube [F].
4. Make sure that the line on the inner tube [D] aligns with the position of the sticker marker [E].
5. Now using a hex key tighten the two bolts on the frame clips [B and C].

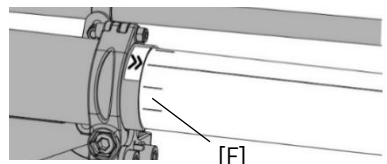
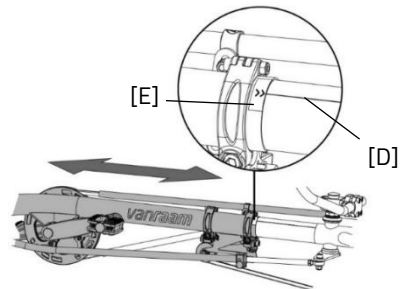
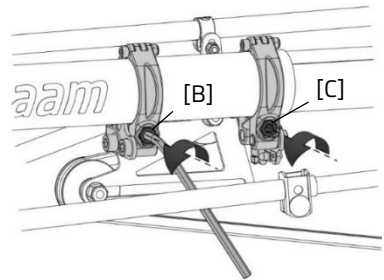
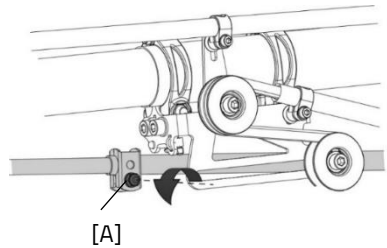
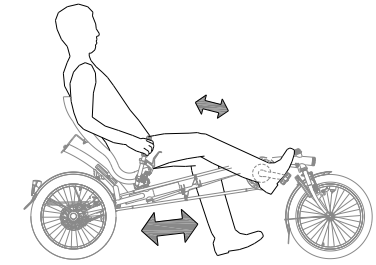

- Put the front wheel in a straight position and use a spanner to tighten the bolt of the steering rod [A].



The front on the frame may not be extended further than the marker [F]. If this is not observed, the inner tube does not reach far enough into the outer tube.



Note that after extending the frame, while tightening the frame clips, these clips are positioned at least 1 cm from the end of the tube. A good indication for this is if the sticker marker [E] is fully visible.

Setting the chain tension of the front chain (Easy Sport and Easy Sport SmaI)

In order to extend the bike further or to alter the position of the derailleur, the chain tensioners [B] can be moved. Follow these steps:

- Loosen the bolt of the chain tensioner [A].
- Re-position the chain tensioner [B] to reach the desired tension.
- Now tighten the bolt [A] back up.

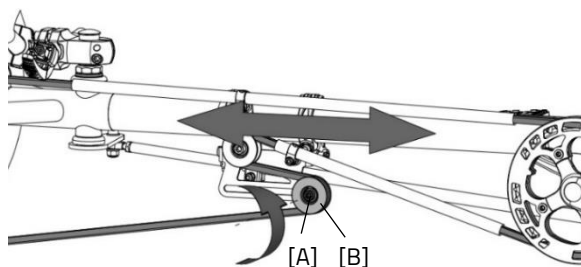

In order to extend the bike to its maximum length, the chain most likely has to be extended by a dealer. When your bike is fitted with a fixed gear or a back-pedal-break, it may also be needed for you to extend or shorten the chain in order to reach the desired frame length. In the chapter **'Repairs and maintenance by dealers'** more information can be found. The chain tensioner [B] described above can then be used in order to set the chain to the desired tension.

Seat height (Easy Sport with comfort seat)

The seat can be adjusted to the desired height. You determine the most comfortable position yourself in practice.

To adjust the height:

1. Loosen the four screws a few turns with an Allen key.
2. Loosen the two nuts a few turns with a wrench.
3. Move the seat to the desired height and re-tighten the nuts and then the screws.

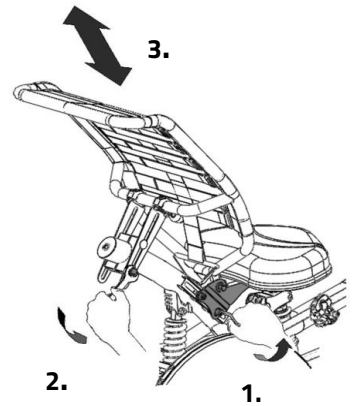

Backrest position (Easy Sport with comfort seat)

The backrest can be adjusted to the desired position. To do this:

1. Loosen the three nuts a few turns.
2. Move the backrest to the desired position and then tighten the nuts again.

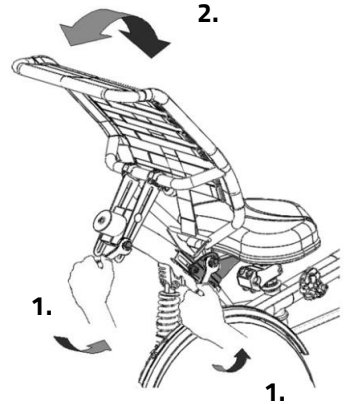

Backrest firmness (Easy Sport with comfort seat)

To make the backrest softer or tighter:

1. Open the straps by loosening the Velcro.
2. Tighten or loosen the straps.
3. Re-attach the Velcro.

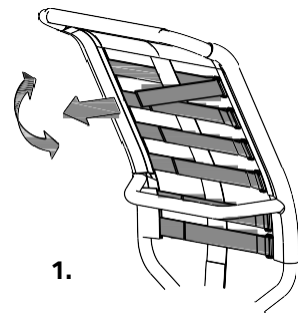

Seat height (Easy Sport with recumbent cockpit)

The seat can be adjusted to the desired height. You determine the most comfortable position yourself in practice. To adjust the height:

1. Loosen the three screws a few turns with an Allen key.
2. Loosen the two nuts on the backrest a few turns with a spanner.
3. Move the seat to the desired height and then retighten the screws and nuts.
4. **Please note:** The bracket can be secured in two ways. By turning the bracket around the seat can be mounted extra high.

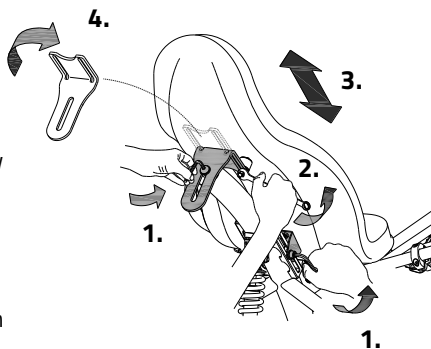

Backrest position (Easy Sport with recumbent cockpit)

The backrest can be adjusted to the desired position. To do this:

1. Loosen the three screws a few turns with an Allen key.
2. Move the backrest to the desired position and then tighten the nuts again.

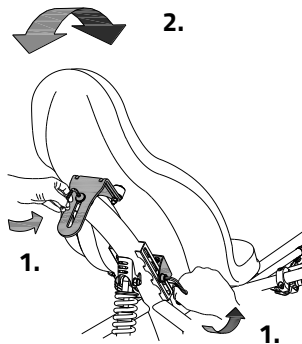

Handlebar position

You can tilt the handlebars. You determine the most comfortable position yourself in practice. To tilt the handlebars:

1. Loosen the three screws a few turns with an Allen key.
2. Place the handlebars in the desired position and then tighten the screws firmly.

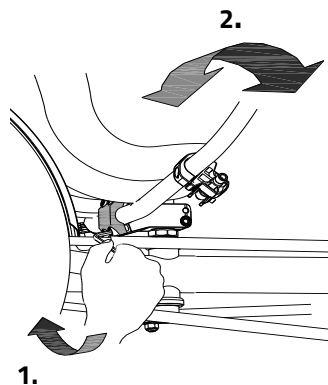

Before use

Parking brake

Always use the parking brake when you park (and leave) the bike. The image shows the parking brake in the parked position.

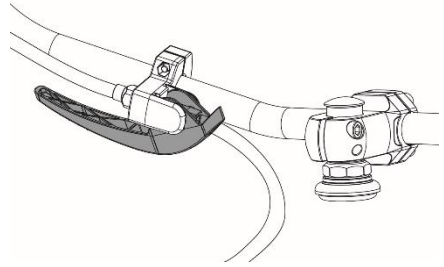

Always try to park the bicycle on a level surface. It is not recommended to park the bicycle on a slope steeper than 10%.

Lighting

Normally, the lighting on the bicycle can be manually operated and adjusted to different positions. When the bicycle is equipped with the Electro system Silent, the lighting switches on automatically when the electrical system is activated. Below, the operation of both the manually operated lighting and the centrally operated lighting is explained.

Manually operated headlight

The headlight has a push button with three positions: ON – ON [50%] – OFF.

Adjust the angle of the headlight so that the center of the light beam is approximately ten meters in front of the bicycle.

The headlight works with batteries. When the batteries are low, a red LED button lights up where the headlight's push buttons are. Follow the steps below to replace the batteries.

1. Open the lamp by pressing down on the lip of the housing and pulling the front of the lamp off.
2. Replace the two alkaline batteries (2x AA).
3. Reassemble the lamp by first pressing the top into the housing and then snapping the bottom back into place behind the lip.

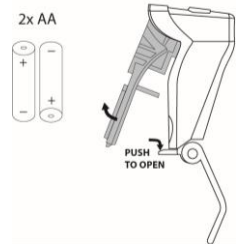
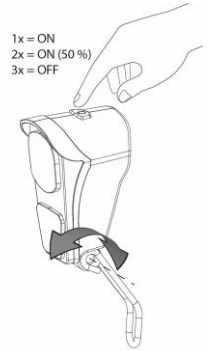

Only operate the lighting when stationary to avoid dangerous situations and the risk of injury.

Manually operated rear light

The rear light has an on/off button with which **Off-Auto-On** can be set.

The seating is as follows:

Press 1x lighting is on

Press 2x lighting is automatic

Press 3x lighting is off

In the "On/Off" position, the rear light can be switched on or off manually.

In "Auto" mode, the rear light turns on or off automatically using light and motion sensors. If no movement is detected after some time, the lighting will switch off automatically.

The headlight works with batteries. When the batteries are almost empty, a red LED on top of the rear light will flash. Follow the steps below to replace the batteries.

1. Remove the cover from the housing by pressing in the lip on the bottom.
2. Replace the alkaline batteries (1.5 V – 1500 mA) and fit the cover.



Batteries pollute the environment. When disposing of, please follow local regulations.

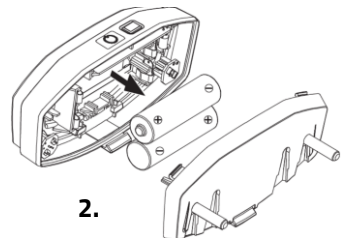
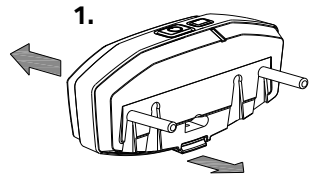
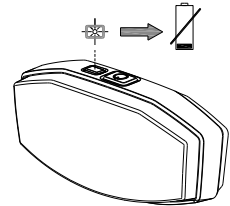
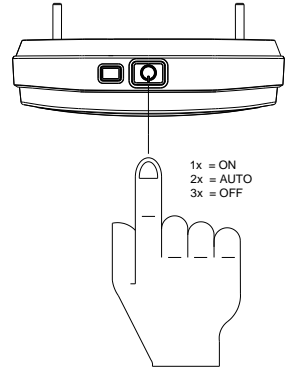

Centrally operated lighting

The bicycle is equipped with centrally operated lighting (front and rear) with the lighting connected to the electrical system.

The lighting switches on automatically when the electrical system is activated.

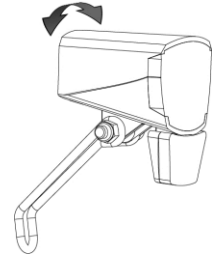

Adjust the angle of the headlight so that the center of the light beam is approximately ten meters in front of the bicycle.

You can switch the lighting on and off manually by briefly pressing the on/off button on the display. When the electrical system is switched off, the lighting switches off automatically.



Make sure that there is always a charged battery on the bike when you go cycling in the dark!

As soon as the battery is almost empty, the motor no longer provides assistance while cycling. The operable lighting will still work on the residual power.

Gears

The bicycle is optionally equipped with gears.

The gears are operated by turning the handle.

Don't pedal while turning the gears.

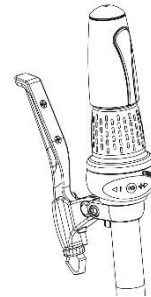

Before you actually start cycling, read the chapter '**Safety Precautions**' and make sure you understand it.

Silent electrical system

Item number: -2195

The Silent electrical system comprises 5 components: display, button unit, battery, motor and bottom bracket. How the first 3 parts are used is explained in this user manual.

Operation of the display

The display provides you with cycling information, which will be explained in more detail later. The display is mounted onto the handlebars by means of a bracket. The display cannot and does not have to be removed when leaving the bike.

(1) On/off

This button switches the electrical system on.

(2) Bicycle lights

The lights on the bicycle switch on automatically when the electrical system is switched on. By pressing this button briefly, the lights can be switched off (and on).

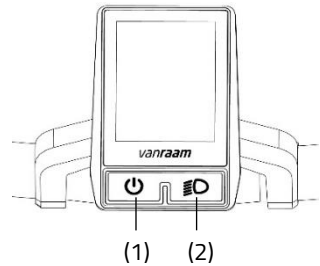

Operation of the button unit

The button unit is mounted next to the handlebar grip. You use the button unit to operate the electrical system.



The button unit can be mounted on the other side of the handlebars by your dealer.

(3) Mode

By pressing this button briefly, you can switch between the different Screen modes.

(4) Plus - Increase pedal support power assistance

(5) Minus - Reduce pedal support power assistance

(6) starting aid

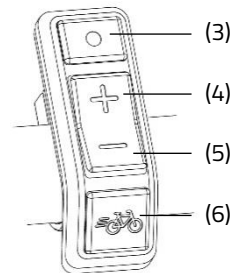

Information screen

After the electrical system is powered up, the information screen is displayed. This screen displays real-time cycling information.



The information screen will only work if you have switched on the electrical system.

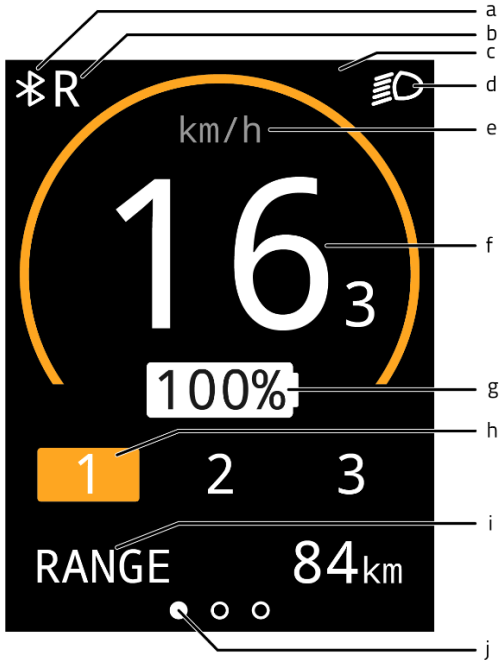

- (a) Bluetooth connection
- (b) Reverse function of (thumb) throttle activated
- (c) Notification field
- (d) Bicycle lights
- (e) Speed indicator
- (f) Speed
- (g) Battery charge percentage
- (h) Assistance mode
- (i) Screen modes
- (j) Screen mode orientation bar

Screen modes

The screen mode (i) can be set by using the mode button (3) You can switch between the following 3 screen modes while cycling.

1. Radius of action [RANGE] (default display)
This is the number of kilometres that can still be cycled with the remaining battery capacity in the active assistance mode.



The range is assistance mode dependent and is an estimate, so the actual range may differ from the estimate. The range is dependent on several factors. Among others, the range is influenced by: battery capacity, amount of assistance, tyre pressure, ride speed, rider weight and load, and the environment.

2. Trip distance [TRIP]
This is the distance travelled since the trip odometer was last reset. By holding down the mode button for one second, the trip odometer can be reset to 0.
3. Total distance [TOTAL]
This is the total distance travelled by the bicycle when the electrical system has been switched on.



Settings screen





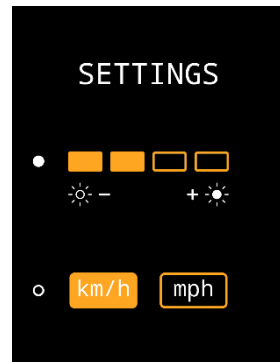

In the settings screen, the brightness of the display and the units of distance and speed can be changed.

To access the settings screen, the mode button (3) and the plus button (4) should be pressed down simultaneously for one second. Using the mode button (3), you can switch between the settings. The plus and minus buttons (4,5) are used to adjust the setting. To exit the setting screen, press and hold the mode button (3) for one second.



Notifications

Several symbols can be displayed in the information screen. The symbols are explained below. More information on the notifications can be found in the chapter **"Possible Faults"**.

-  The bicycle lights are activated
-  A Bluetooth connection is active
-  No communications with the battery
-  Reverse function of (thumb) throttle is activated
-  The temperature of the controller is too high
-  Voltage is too high
-  Fault

Pedal support power assistance

The Silent electrical system provides assistance while cycling.

Starting aid

With the starting aid, pedal assistance is activated up to a speed of 6 km/h, without having to pedal yourself. To do this, press and hold down the starting aid button (6). If the button is pressed again, the function is reactivated.

If you press the starting aid button while cycling, you will get a "boost". This boost will have the same maximum speed as the bike. The activated pedal assistance mode determines the degree of assistance of the starting aid and the "boost".

The starting aid button can be used for:

- Extra assistance when starting off (starting aid).
- Extra assistance when cycling uphill (boost).

Assistance settings

The pedal assistance level can be set using assistance settings 1, 2 and 3. The assistance settings can be changed while cycling.

1. Low level of assistance, maximum range.



2. Average support, average range.



3. Maximum support, low range.



Reverse pedalling

The reverse function is activated by pedalling backwards from a stationary position. After a few turns of the wheel, the motor is activated and the bicycle will reverse at the speed of 3 km/h for as long as it is pedalled backwards.



Do not let the electric motor's sudden behaviour take you by surprise. For example, if you wait at the traffic lights and pedal backwards just for fun, the reverse function will be activated and the bike will start riding backwards!

Presets

A preset is a set of settings which sets the level of assistance. By loading a different preset, the level of assistance for all assistance settings can be adjusted. Presets can be changed by the dealer or through the Van Raam app.

Van Raam E-Bike app

With the app, you can track various information and configure the assistance modes. (More information on this can be found in the chapter on the Van Raam E-Bike app)

Charging the battery

To charge the battery:

1. Unlock the battery by turning the key a quarter turn.
2. Press the lock in and simultaneously pull the battery pack out of the holder with your other hand.
3. Take the battery with you inside. **First** plug the charger into the power outlet. The green LED will light up. The charger is now on stand-by.
4. **Then** plug the charging connector of the charger into the charging point of the battery. The red LED will light up. The charger is now charging.



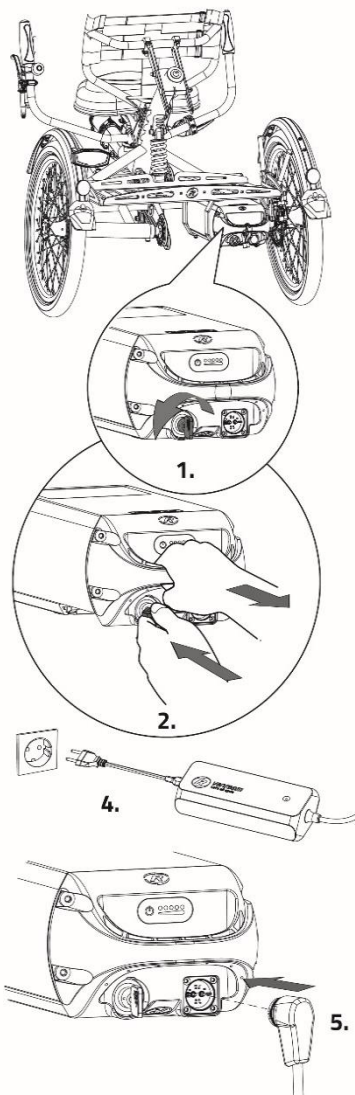

Caution! *If the battery is not properly connected, then the green LED will be on (standby mode). In case of an unsatisfactory connection, unplug the charger from the power outlet and clean its connector with a dry cloth.*

5. The charging time depends on the battery status. The charging time is approximately 2 hours for a 11.4 Ah/36 V battery and approximately 4.5 hours for a 24.8 Ah/36 V battery.
6. As soon as the battery is fully charged, the green LED will light up continuously. Now **first** remove the charging connector from the battery.
7. **Then** remove the charger's plug from the power outlet.
8. Place the battery back into the holder on the bicycle and lock the battery. Optionally, the battery can also be charged directly in the holder.



Charger indicator light

The status of the charger is indicated by the coloured indicator light.

-  If the indicator light is green, the charger is in standby mode or the battery is full.
-  If the indicator light is red then the charger is charging the battery.
-  If the indicator light flashes red then the charger is in safety mode.

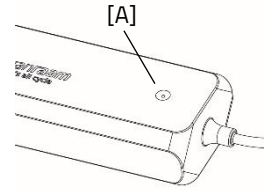

Caution! Unplug the charger from the power outlet.



Only use the charger when the ambient temperature is between 0 and 35 C.





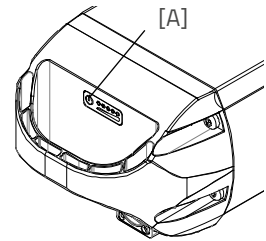

It is better for the battery to be charged periodically instead of waiting until it is completely empty.

Battery indicator lights

On the battery pack there is an LED indicator to check the battery charge status. The battery charge status can be read by briefly pressing the on/off button [A]. While the battery is being charged, the indicator shows the charging progress:



-  The battery is fully charged. When the battery is used, the number of green lamps will decrease.
-  If two green lamps are lit, the battery is 50% charged.
-  If only the left LED remains green, the battery is almost empty and needs to be recharged or replaced with a charged battery.
-  If the left LED starts blinking green, the battery is empty and the motor will not support cycling for much longer. However, the switchable lighting will still work after that.



Never put the bike away with an empty battery.

Deep sleep battery mode

When the battery is almost empty and has not been used for a week, the battery will go into a "deep sleep mode". In this mode, the battery uses as little energy as possible, which extends the battery life.

When "deep sleep mode" is activated, the battery cannot be used. By pressing the on/off button [A] on the battery, the battery will be released from 'deep sleep mode' and can be used again. It is advisable to charge the battery before using it.

Charging and maintenance of the battery pack

Important safety warning:

- To ensure the battery's optimal condition and capacity, we recommend charging it indoors at room temperature.
- Never put the bicycle away with an empty battery. We recommend charging the battery as soon as possible when it is empty. The best storage charging level for the battery is when the charge display shows three to five LED lights.
- In winter, check the battery charge every other month, recharge it if less than three LEDs light up.
- Preferably store and use the battery between 5 and 20 C, avoid higher and lower temperatures.
- Do not charge the battery in direct sunlight and make sure that the battery is not charged at a temperature lower than 5 C.
- Only use the charger in dry indoor areas, the charger is not allowed to get wet.
- Only use the supplied Van Raam battery and charger.
- The housing of the battery and the charger must not be opened. In case of any problems, please consult your dealer.
- A Van Raam battery is not allowed nor is it possible to recondition the battery due to safety reasons and incorrect functioning of the electrical system.
- Do not drop the battery as this can cause external and internal damage.
- If the bicycle malfunctions, the battery must be disconnected from the bicycle.



Keep in mind that the bike provides less assistance at lower temperatures (0°C and below) and that the battery will drain more quickly. It also takes longer to charge at low temperatures.



Every battery drains over time. This process is called 'self-discharge'. A battery that is empty and not charged can undergo a deep discharge caused by self-discharge and become faulty as a result. The warranty is voided in the case of a deep discharge.



Keep in mind that every battery wears out over time. The wear and tear process of the battery is inevitable and depends on several factors such as use, the number of times to fully discharged and charged and the ambient temperature. Even if the battery is not used, its capacity will decrease. A worn-out battery can be used, but keep in mind that the range will be reduced.

Possible faults

- The system cannot be switched on:
 1. Check that the battery is attached properly.
 2. Check the status of the battery. If it is empty, charge the battery.
 3. If the above does not provide a solution, please contact your dealer.
- If a red LED flashes on the charger, unplug the charger from the power outlet and stop using the charger and battery. In this case, contact your dealer.

Faults table

Fault symbol/ code	Description	Consequence/ course of action
All assistance modes are flashing	Temperature controller too high	System does provide assistance, motor power is reduced.
Thermometer (symbol) + all assistance modes are flashing.	Temperature controller too high	System does not provide assistance, let the controller cool down.
Battery with cross (symbol) + all assistance modes are flashing	No communications with the battery	System does provide assistance. Contact your dealer.
Lightning bolt (symbol) + assistance settings are turned off	Voltage too high	System does not provide assistance, voltage drops automatically when cycling speed is slower than maximum assistance speed.
Exclamation mark (symbol) Exclamation mark (symbol)	Voltage too low	System does not provide assistance, check the connection between controller and battery. Check how full the battery is.
	Controller communication error	System does not provide assistance. Contact your dealer.
Active assistance mode is flashing	Electrical current too high	System does not provide assistance. Contact your dealer.
Active assistance mode is flashing	Motor sensor fault	System does provide assistance. Contact your dealer.
All assistance settings are turned off.	The battery is almost empty.	Charge the battery

Charging and maintenance of the battery pack

Important safety warning:

Charger safety precautions

- Only charge Van Raam Li-Ion batteries with the supplied charger. Only connect the charger to a suitable wall socket (220–240 Volt AC 50-60 Hz). When the charger is not in use, disconnect it from the power outlet and the power plug from the battery.
- The charger may only be used by persons who have read the information in this manual and are familiar with the correct use of the charger. Keep the charger out of reach of children; they should not play with the charger.
- The charger is designed for use in a dust-free, dry and ventilated environment. Do not expose the battery to water, heat sources and direct sunlight. Keep the charger clean and dry.
- Do not charge batteries that feel hot. The battery may only be charged in places where the temperature is no higher than room temperature. Stop charging if the battery gets hotter than ($> 40^{\circ}\text{C}$).

Caution! The charger can become warm during charging $> 50^{\circ}\text{C}$. First, carefully feel whether you can pick up the charger, this temperature can cause hypersensitivity or a startled reaction when it comes into contact with the skin.

- Do not use the charger if it is visibly damaged or modified. Do not repair the charger yourself! Please contact Van Raam. You are strictly prohibited from opening the charger yourself!
- Always keep an eye on the charger and battery while charging. When the battery is full, disconnect the power plug from power outlet and remove the power plug from the battery.

Silent Electrical System options

There are different options for the electrical system for each bicycle model.

External charging point

Item number: -2161

In order to make battery charging more accessible, the bicycle can be equipped with an external charging point in the backrest. The battery does not have to be removed from the bicycle to be charged. The external charging point is placed on the seat closest to the battery.



If it fails to charge, check whether the power plug of the external charging point is properly connected to the battery.

Spare battery

The bicycle can be equipped with a second battery. The second battery can be used when the first battery is empty. The batteries will need to be swapped.

Switchable battery pack

Item number: -2165

If you have two batteries, the bicycle can be equipped with the switchable battery pack option. Once the connected battery pack is empty, you can switch the system to the second battery pack by using the switch. This is located under the seat, carrier or battery.

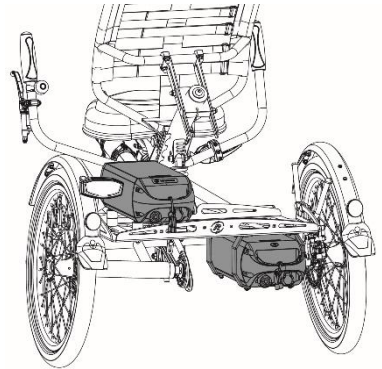

The switch has three settings:

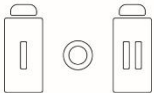

- I: Left battery is connected to the system.
- 0: No battery is connected to the system.
- II: Right battery is connected to the system.

Thumb throttle

Item number: -2183

The bicycle can be fitted with a thumb throttle. The thumb throttle is mounted next to the handlebar grip and can be operated by the thumb. When the throttle lever is operated, the bike will travel up to a maximum speed of 6 km/h without the need to pedal.

The switch on the throttle lever can be used to switch between forward and reverse gears. When the switch is set to '0', the bike will start riding forwards as soon as the throttle is operated, and when the switch is set to '1', the bike will start riding backwards at a maximum speed of 3 km/h.

Direction indicator

Article number: -4170

The bike can be equipped with a direction indicator. To operate the direction indicator, press the switch [A] on the handlebar to the left or right.

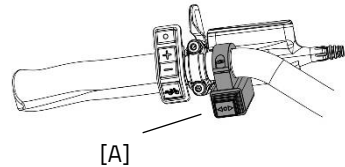

The direction indicator is powered by the battery of the Silent electrical system.



Please note that the turn signal can only be activated when the bicycle's lighting is turned on.

Van Raam e-bike app

The Van Raam bicycle app is a free smartphone app that you can use while cycling on your electric Van Raam bicycle.

What can you do with the Van Raam e-bike app?

- App can be used as a luxury bicycle computer
- Change bike settings
- Send SOS messages with GPS location to a number of your choice
- View cycled routes
- View information about the bike

How does the Van Raam e-bike app work?

With the Van Raam e-bike app, a connection can be made with the display via Bluetooth connection. As soon as the display is ready to connect to the smartphone, the on/off button will briefly turn blue.



This app can be used as a luxury bicycle computer for Van Raam bicycles with pedal assistance and also contains many other extra functionalities. The dashboard on the app shows the current speed, total distance, trip meter, battery capacity and power consumption during the bike ride. For more cycling data, there is a details screen including average speed, maximum speed, total distance, battery voltage, pedaling power and pedaling frequency.

The Van Raam e-bike app can be downloaded free of charge from the **Google Play Store** or **Apple App Store**.

For more information about the Van Raam e-bike app, you can visit the Van Raam website: www.vanraam.com.

Options

Options are suitable for both the Easy Sport and Easy Sport Small unless otherwise indicated.

Crank shortener

The crank shortener is attached to the crank (as shown). The pedal can then be mounted in two positions in the crank shortener.

With the adjusting screw [A], the crank shortener should be aligned with the crank.

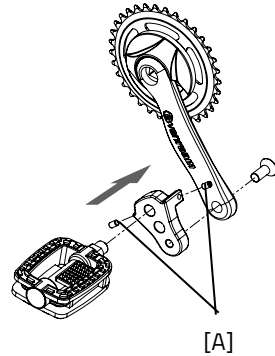

Stick holder

You can take two sticks with you in the stick holder. Place the stick in the holder at the bottom [A] and then press the stick into the clips [B].

Always secure the stick(s) with the Velcro.

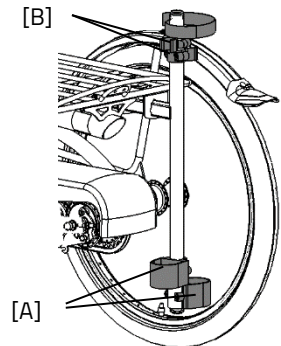

Foot fixation

With the foot fixation you can fix the foot by sliding the two notched straps [A] into the quick releases [B].

The quick release can be unlocked by pulling the lip back completely. The notched strap can then be pulled out.

The notched straps can be cut to size. The strap must maintain an excess length of at least five centimeters.

The position of the foot fixation on the pedal is adjustable in length. This allows you to pedal with the ball of the foot to apply optimal force.

1. Loosen the four nuts a few turns with a socket wrench.
2. Move the plate, including the footrest, forwards or backwards into the desired position. Then re-tighten the nuts.

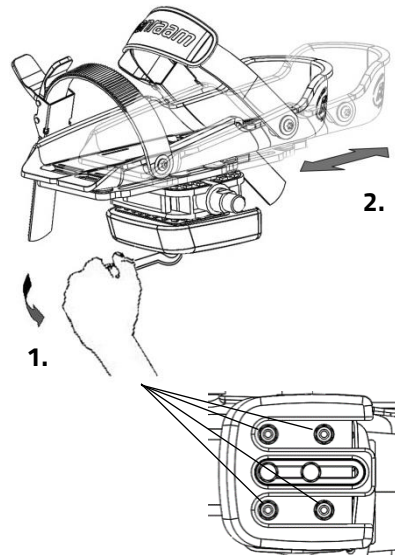
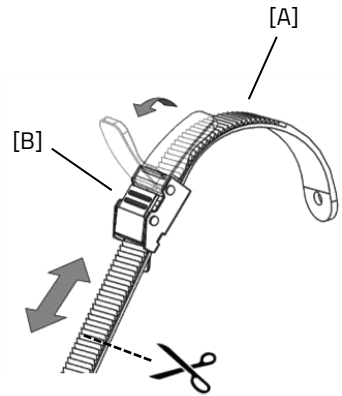

The foot fixation returns to its neutral position when not in use. The neutral position can be determined by sliding the balance block.

1. Loosen the two nuts a few turns with a socket wrench.
2. Slide the balance block into the desired position. Then re-tighten the nuts.

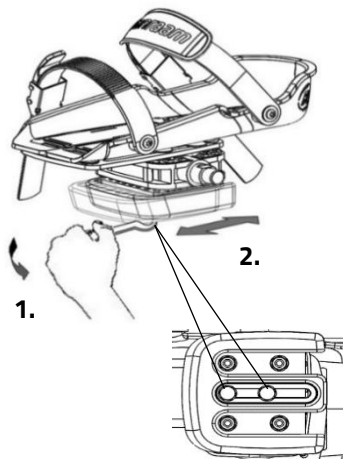

The footrest is also adjustable in width. Only the outer footrest can be moved.

1. Loosen the two bolts a few turns with an Allen key.
2. Move the footrest half to the desired position. Then re-tighten the nuts.

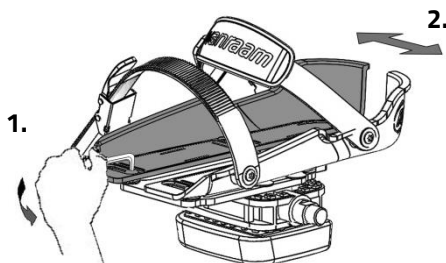

With the pedal extension, the footrest halves can be pushed further apart.

Tip: When adjusting the footrest, bring the rear parts together in a V-shape. This will give you a better fit, as a foot is narrower at the back than the front.



The small footrest (Fix20) is suitable for size 22 to size 36. The width of the reach of this footrest is min. 6.5 cm to max. 9 cm. The large footrest (Fix25) is suitable from size 37 to size 48. The width of the reach of this footrest is min. 8.5 cm to max. 13 cm.

Lower leg fixation

With the lower leg fixation option, you can fix the lower leg. To adjust the lower leg strap:

1. Loosen the bolt [A] a few turns with a wrench. Adjust the height of the lower leg fixation so that it matches the rider's lower leg. Then re-tighten the bolt.
2. Loosen the two nuts [B] a few turns. The angle of the leg cup can now be adjusted. Rotate the leg bowl to the correct position and then retighten the nuts.
3. Use the Velcro to secure the lower leg.

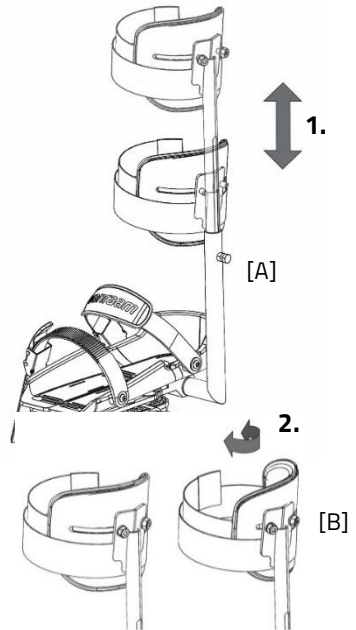

4-Points belt

To open the belt, the buckle button [A] must be pressed. Then the buckle can be pulled apart. The 4-points belt is adjustable in length. This can be done by loosening the belt clips [C] on the back of the backrest. Now the desired length of the belt can be set using the buckle [B]. Then close the belt clamps [C] again. With the clamp buckle [D] you can tighten or loosen the belt.



The illustration does not quite match the seat of the Easy Sport. But the seat belts are the same.

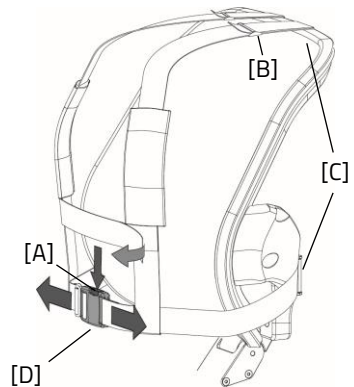

Direction indicator

Only Easy Sport

To operate the direction indicator, push the switch [A] to the left or right. If you want to turn off the direction indicator, put the switch in the middle position.

The direction indicator works with batteries. To replace the batteries, loosen the screw on the cover and remove the orange cover [B]. You then remove the circuit board [C] from the holder. You can now replace the battery [D]. This is a 3-volt lithium battery, type CR123A.

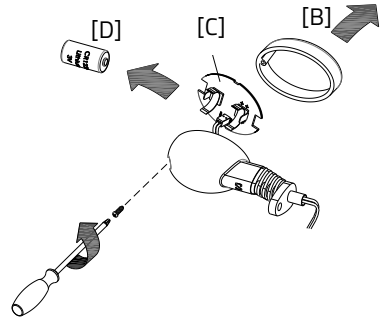

Batteries pollute the environment. When disposing of, please follow local regulations.

Gear lever

The position of the gear lever can be determined based on the position of the shifter and the user's preference. To adjust the lever, the bolt [A] must be loosened a few turns with an Allen key. Now the lever can be adjusted to the desired position. Then tighten the bolt so that the lever clamps around the shifter sufficiently. **Please note!** Do not tighten the bolt more than necessary.

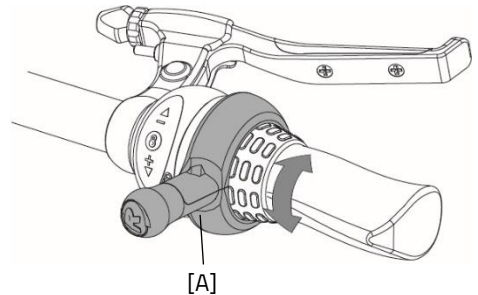

Technical specifications

	Easy Sport Small	Easy Sport
Inseam (cm)	47 - 73	65-105
Length (cm)¹	171-186	195-225
Width (cm)	78	80
Height (cm)	87	104
Entry height (cm)	41	52
Front tire	16"	20"
Rear tire	16"	20"
Weight (kg) configuration without electrical	37	39
Max. weight user (kg)	80	120
Max. baggage tray (kg)	20	20
Brakes, front	Mechanical rim brake with parking brake function	Mechanical rim brake with parking brake function
Brakes, rear	Hydraulic disc brakes or backpedal	Hydraulic disc brakes or backpedal
Suspension (lbs/inch)	250	750

¹ Length (cm) at standard version. Due to possible modifications to the bike, the length may vary.

Cleaning and maintenance by owner

Below are instructions for maintenance and adjustments that you can carry out yourself on a regular basis. This keeps the condition of the bicycle optimal.

Cleaning

The frame of the tricycle can be cleaned with a damp cloth. You can use a mild detergent for dirty spots.

The wheels can be cleaned with a damp brush with plastic bristles (no wire brush!) The saddle, the handles and the backrest can be cleaned with mild soap and water.



Do not use a high pressure- or steam cleaner!

The right lubricant

The chain should be cleaned and preserved regularly (approximately every three months). Only use special chain grease or Teflon spray. This is the only way to ensure that the chain runs smoothly, remains water resistant and does not rust.

1. Wipe the chain with a cloth.
2. Treat the chain with grease or spray.
3. Rub off excess lubricants with a cloth.

Other parts should **not** be treated with a lubricant.

Inspection of the tricycle

It is necessary that the tricycle is inspected at least annually by a dealer in order to be able to continue to claim under the warranty. Use the "Service, maintenance and modifications form" at the back of this manual. The first service should be carried out after the first 200 kilometres or after two months.

In case of malfunctions or defects, **immediately** contact the dealer for repairs.

The replacement of safety-related components (especially frame, brakes, lighting, handlebars, front fork and drive) must be carried out by your dealer.

If you do want to replace components yourself, you are liable for damage or injury as a result of incorrectly mounted components.

Only use **original** Van Raam spare parts, you can purchase these from your dealer. Upon request, the dealer will provide the necessary information for repair and maintenance.

Repair and maintenance by dealer

During the service, check the brakes, rims, lights, chain tension and spokes. Also check the tread depth of the tires. This must be at least one millimetre. Worn tires or any defective parts must be replaced. Check the operation of the parking brake. With the fixed parking brake applied, the tricycle with rider on it may not ride away.

Checking the rim

Due to the interaction of both the brake and the rims, not only the brake lining, but also the condition of the rim is important. For this reason, the rim should be checked at regular intervals, for example when inflating the tire. The presence of fine cracks in the rim flange at the spoke nipples or deformation of the rim with increased air pressure in the tire indicate greater wear. In that case, the rim must be replaced, because otherwise this can lead to a reduction in the braking effect or even a break in the rim with all the dangerous consequences that entails.

Repairs, maintenance and modifications may only be carried out with original Van Raam parts.

Tightening torques

Onderdeel	Moment
Headset bearing handlebar	Free of slack
Headset bearing front fork	Free of slack
Motor nuts	50 N
Bottom brakcet bolts	30 Nm
Crank bolts	37 Nm
Calliper bolts	10 Nm
Wheel bolts	30 Nm
Wheel nuts	37 Nm
Chest bolt backrest	25 Nm

Adjusting chain tension Easy Sport and Easy Sport Small

For the Easy Sport, thanks to the derailleur, in most cases it is not necessary to adjust the tension of the front chain. In the case of the coaster option, back pedal brake or with body height above 1.90m this is the case. Here the front chain will have to be adjusted by a dealer if the frame length is adjusted.

For tensioning the rear chain of the Easy Sport and Easy Sport Small the following actions have to be taken.

1. Loosen up the bolt [A]. using a spanner, prevent the nut from spinning as well.
2. Push the chain tensioner [B] up or down in order to tension the chain.
3. Once the chain has the desired tension, tighten the bolt [A] back up.

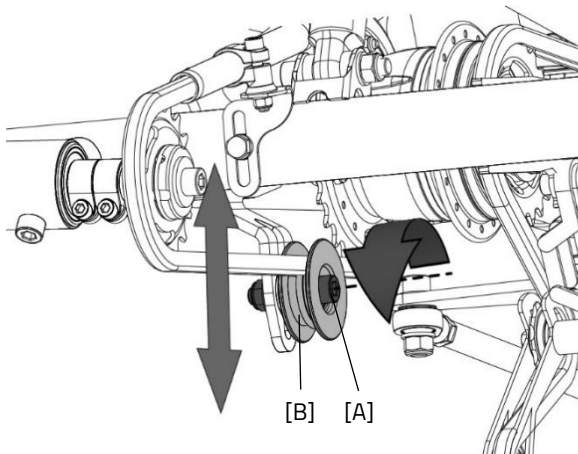

Return point for removal

If you want to return the bike, please contact your dealer. You can also contact the local waste disposal company. He will recycle the bike according to the rules of your place of residence.

Recycling the battery

If your battery is defective or if you are not longer using it, you must have it recycled. Please contact your dealer. They are responsible for complying with the recycling obligation. Ask them about the conditions or view the rules regarding recycling in your place of residence/country.

Handover / sale to a new owner

If you transfer the tricycle to a new owner, it is important that you hand over all necessary technical documentation and spare keys, so that the new owner can use the bicycle safely.

Do you use the Van Raam E-Bike App and have you linked your bike and battery to the app? Make sure you disconnect the bike and battery from the app when transferring/selling. **Please note!** Your cycled routes will not be lost and you can always continue to view them in your Van Raam E-Bike App account. The next owner cannot view your cycled routes.

Warranty

The warranty applies to all product defects for which it has been proven that the cause is a material or manufacturing defect.

We give a five-year warranty on the frame and front fork. For all accessories and other parts (with the exception of wearing parts), we apply the statutory warranty period of two years. The warranty only applies to normal use and maintenance of the bicycle, as described in this user manual.

Please note!

Both the warranty and the product liability in general expire if the instructions in this user manual are not followed, if maintenance work has been carried out incorrectly or if technical changes or additions have been made to the bicycle with non-original Van Raam parts, without permission from Van Raam. The original CE-declaration on the bicycle will also lapse in the event of adjustments by third parties. The lack of a CE-declaration can lead to problems when insuring the bicycle and in the event of damage or liability.

Frame number

You will find the frame number on the sticker. This sticker is applied to the frame, see pictures.

Example sticker:



Position sticker Easy Sport and Easy Sport Small:

Easy Sport

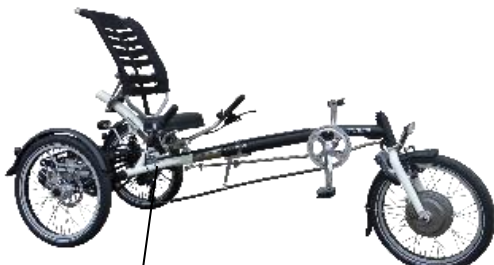

Under the seat tube

Easy Sport Small

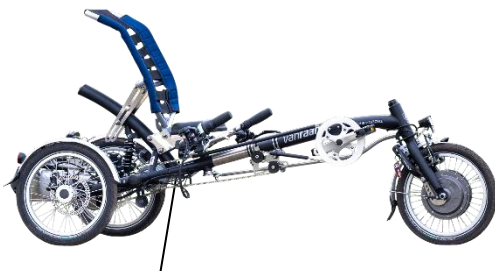

Under the seat tube

Maintenance recommendation

A Van Raam bike often is subject to extensive use and must perform in all weather conditions. By correctly maintaining the bike, the lifecycle can be extended greatly. This maintenance can be done by a Van Raam dealer. In most cases, you can do the monthly and annual inspection yourself.

Maintenance Overview:

What	One-person bike	Multi-person bike	Duration	By whom?
1 st service moment	3 months/300 km	3 months/200 km	15 min	Dealer
2 nd Service moment	6 months/1.000 km	6 months/500 km	15-30 min	Dealer
3 rd Service moment	12 months/2.000 km	12 months/1.000 km	30-90 min	Dealer
Monthly inspection*	Every month	Every month	15 min	User
Annual inspection*	Every 12 months	Every 12 months	60 min	User

* This is advised to extend your bike's lifecycle. You can also have this done by your dealer.

Monthly inspection

15 minutes

Among them:

- Check and inflate the tyres
- Check the chain tension and grease if needed
- Tighten bolts/nuts where needed
- Check all lights
- Check the brakes
- Check all rotating parts and grease if needed
- Clean the bike

Annual inspection

60 minutes

Among them:

- Check and touch up the paintwork
- Check the wheels for any buckling
- Check the spoke tension
- Check the steering ball joints
- Check all lights
- Check the saddle clamp
- Check the placement of all electric components (E-Bikes only)

1st Service moment

15-30 minutes

Among them:

- Check tyres and inflate
- Check the spoke tension
- Check the chain tension and grease
- Tighten any bolts and nuts if needed
- Check all brake cables and brake calipers
- Check the gears
- Check and grease all rotating parts
- Check all lights
- Clean the bike

2nd Service moment

30-90 minutes

Among them: All points from service moment 1, and:

- Inspection of the pedals and bottom bracket
- Grease and tighten the lock
- Grease and tighten the steering stem
- Check the steering ball joints
- Run all tests in the dealer tool (E-Bike)

3rd Service moment

60-120 minutes

Among them: All points from service moment 1, 2, and:

- Inspection of the paintwork
- Inspection of the frame/front fork
- Inspection of the seat cushions
- Inspect the functioning and sound of the motor/gear hub
- check reflectors for any damage
- Check all electric components on their placement (E-Bike)
- Run all tests in the dealer tool (E-Bike)

Service plan

1st Service moment

- Yes/No
- Dealer:
- Mechanic:

Date:

Remarks:

.....

.....

.....

.....

2nd Service moment

- Yes/No
- Dealer:
- Mechanic:

Date:

Remarks:

.....

.....

.....

.....

3rd Service moment

- Yes/No
- Dealer:
- Mechanic:

Date:

Remarks:

.....

.....

.....

.....

Annual inspection

Date	Dealer	Mechanic	Remarks

Delivery and service form

Congratulations on your Van Raam bicycle. This bicycle has been produced with the utmost care. To guarantee a high quality as much as possible, Van Raam produces the bicycles according to the ISO 9001: 2015 quality requirements. Van Raam has been certified for this by DNV GL Business Assurance B.V.

You can optimally enjoy this Van Raam bicycle, specially produced for you, if the bicycle is adjusted to your requirements and the instructions in the user manual are followed. Make sure to observe the service intervals prescribed in the operating instructions.

To be able to claim service and warranty, you must always fill in the forms at delivery and service intervals. With this form, the dealer and the end user also sign that the end user has been instructed about the operation of the bicycle, that the bicycle has been adjusted to the wishes of the end user and that the end user has received the original Van Raam manual.

Fill in when delivering the bicycle

Van Raam bicycle type:	
Frame number:	
Key number:	
Delivered to:	
By dealer:	
Location:	
Date:	
Signature bicycle user:	Signature dealer:
Dealer stamp (if available):	