



## User manual



### VeloPlus3

Van Raam  
Guldenweg 23  
7051 HT Varsseveld, The Netherlands

☎ +31 (0)315 – 25 73 70

✉ [info@vanraam.com](mailto:info@vanraam.com)

🌐 [www.vanraam.com](http://www.vanraam.com)

Version 23.03



# Table of contents

Manufacturer contact details .....	3
Conformity Europe (CE) .....	3
Conformity UK (UKCA) .....	3
Introduction.....	4
Delivery.....	4
Indication.....	5
Intended usage .....	5
Safety measures.....	6
Adjustment of the tricycle .....	8
Before the first use.....	13
Electro system Silent .....	20
Van Raam e-bike app.....	30
Accessories.....	32
Technical specifications .....	38
Maintenance and adjustments to be done by owner.....	39
Repairs and maintenance to be done by dealer .....	40
Adjustments by dealer .....	41
Disposal .....	42
Handover/sale to a new owner .....	42
Guarantee .....	43
Frame number.....	44
Maintenance recommendation .....	45
Service plan.....	47
Delivery and service form.....	51

## Manufacturer contact details

Van Raam

Guldenweg 23

7051 HT Varsseveld, The Netherlands

☎ +31 (0)315 – 25 73 70

✉ [info@vanraam.com](mailto:info@vanraam.com)

🌐 [www.vanraam.com](http://www.vanraam.com)

## Conformity Europe (CE)

Van Raam Reha Bikes B.V., as manufacturer, declares that the VeloPlus3 as described in this user manual is manufactured in accordance with Regulation (EU) 2017/745, risk class 1. The VeloPlus3 supplied with the Silent electrical system also complies with Directive 2006/42/EC including the applicable parts of EMC Directive 2014/30/EU and the NEN-EN 15194:2017 Bicycles - Electric supporting bicycles - EPAC Bicycles - part 4.2 Electrical requirements. The signed declaration of conformity can be found on the Van Raam website.

## Conformity UK (UKCA)

Van Raam Reha Bikes B.V. as manufacturer declares that the VeloPlus3, as described in this user manual, is manufactured in accordance with the "Essential Requirements of Medical Devices Regulation 2002" (UK MDR 2002 Class 1 Medical Devices). The VeloPlus3 supplied with the Silent electrical system also complies with the "Machinery (Safety) Directive SI 2008/1597" including the applicable parts of "Electro Magnetic Compatibility Regulations SI 2016/1091" and the NEN-EN 15194:2017 Bicycles - Electric support bicycles - EPAC Bicycles - part 4.2 Electrical requirements. The VeloPlus3 is provided with UKCA label according to "EU Exit Regulations 2020/1478". The signed declaration of conformity can be found on the Van Raam website.

## Introduction

This user manual provides important and necessary information about the use of your tricycle. We ask you to read this manual thoroughly before using the tricycle. Always follow the instructions as provided in this user manual and keep the manual carefully. The most current version of the user manual can be found on the product page of the bicycle on the website [www.vanraam.com](http://www.vanraam.com).



**READ CAREFULLY**

## Delivery

The delivery should include the following:

- Tricycle with packaging
- User manual(s)
- Possible Smart-battery including card with 5-digit code (depending on options)
- Possible chargers (depending on options)
- (Spare) keys

Check the delivery immediately after receiving it. In case of damage or incomplete delivery we ask you to contact your dealer immediately. Upon delivery you should fill out the form "Form service, maintenance, modifications and warranty claims" in the back of this manual.

## Indication

The VeloPlus3 is intended for cycling with children or adults who are in a wheelchair and transfer is not possible or difficult.

## Intended usage

The tricycle is designed for normal use on level and solid ground. In general, tricycle caution should always be observed when using the tricycle. Moreover, the safety instructions as described in this manual should be explicitly followed. Local traffic laws and regulations should also be observed.

The tricycle is meant for two persons, one driver and one passenger in his/her own wheelchair. The rider must be independently mobile and may not have any serious visual or other restrictions which prevent responsible participation in traffic. The maximum weight of the rider, passenger and luggage rack load (to be found in the chapter '**Technical specifications**') may not be exceeded.

Before using the bicycle, please read the safety instructions to ensure your wheelchair is suitable for use.

The manufacturer is not responsible for any damage or injury caused as a result of or during the course of any other type of use.

## Safety measures

- Ensure the tricycle is in good condition each time before using it. Check before **each** ride that the brakes are in order. Check the lighting and make sure there is enough tyre pressure.
- Regularly check if the wheels, the handlebars and the saddle are properly fixed and also whether all screw joints are tight.
- Only use the tricycle on a **solid and level surface**.
- It is not recommended to cycle on a slope steeper than 10%, this carries an increased risk.
- Make sure that wide trousers or loose hanging clothing don't get caught in the chain, spokes or pedals.
- Do not use a pressure washer or a steam cleaner for the cleaning of the tricycle.
- Block the tricycle to stop it from moving when you are getting on or off the tricycle. Do this by using the parking brake and holding the tricycle. Also use the parking brake if the wheelchair is driven on or off the ramp.
- Always lock the tricycle when leaving it unattended.
- **Never** drive without a passenger. This will cause instability of the bike and will lead to dangerous situations.
- **Never** place your feet or other limbs under the ramp. You can be hit by moving parts and suffer from bruises.
- **Always** place the wheelchair forward, in the driving direction, on the ramp.
- Your wheelchair is suitable for use when the centre of gravity can be placed above the front wheels of the bicycle and when it can be fixed according to the instructions under the heading 'wheelchair transport'.
- Make sure that once the wheelchair is placed on the ramp, the wheelchair's weight causes the ramp to fold up automatically. When that is the case, the centre of gravity of the wheelchair is situated above the front wheels of the bicycle. This creates the correct weight distribution of the bicycle.
- Extra attention is required for an electric wheelchairs because these often have different weight distributions as a result of which the centre of gravity may not be positioned correctly.
- Make sure that you do not reach a dangerous speed when driving downhill and entering tunnels. Brake in time and bike at a moderate speed.
- In case of pregnancy, extra care is required owing to a higher risk of injury.

- Do not leave the tricycle in direct sunlight: the temperature of some parts could exceed 41°C resulting in possible burns to the skin.
- If your tricycle is equipped with the Silent electric motor system, make sure that you get used to riding with the electric support engaged. Be careful when you turn on the electric support system and make sure you don't get startled by unexpected behaviour because you turned on the electric support.

## Load

The maximum load should not be exceeded. See the information in the technical data table in the **'Technical Specifications'** section of the user manual. By permitted load we mean the total load, including the load on the luggage rack and the wheelchair.

Make sure that the permitted load on the luggage rack is not exceeded. (**maximum 20 kg**). People may not be transported on the luggage rack!

## Damaged or worn out parts

The replacement and repair of parts (frame, forks, light, brakes, drive mechanism and the handlebars) should **always** be performed by an authorised dealer. If not, the guarantee ceases to be valid and you will be personally responsible in the event of possible damage.



Specific safety parts should **always** be replaced by new parts!

## Adjustment of the tricycle

Before using the tricycle, adjust it to the measurements of the cyclist. This is of great importance, especially the saddle and the handlebars.



*If an optimal adjustment of the tricycle, as defined in the instructions, is not possible, you can contact your dealer for a fitting solution.*

The brakes are correctly adjusted and should only be adjusted by the dealer during periodic maintenance.



Take care that fingers and limbs do not get trapped while adjusting the tricycle.

### Saddle height

When the cyclist is sitting on the tricycle and can put a foot on the pedal in the lowest position, the saddle height is correct. Adjust the saddle height in such a way that the leg is stretched but relaxed in that position.

To adjust the saddle:

1. Open the quick-clamp [A].
2. Slide the saddle to the correct height.
3. Close the quick-clamp.

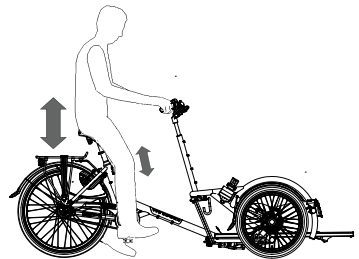

*Make sure clothing cannot get caught in the clamp!*



*If the clamp closes too easily, the clamping force is too low. In this case, open the clamp and tighten the nut [B] a bit more. If a lot of force is necessary to close the clamp, the nut should be loosened slightly.*

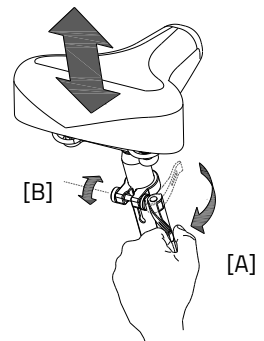





Don't **pull out** the seat post further than the markings. If you do so, the tube won't be inserted deep enough into the shaft, increasing the risk of breakage, which may lead to serious injuries.



## Handlebars height

The height of the handlebars affects the comfort of the ride. It determines the pressure on the hands and the position of the back. You decide the most comfortable position yourself with some practice.

To adjust the handlebars:

1. Slightly loosen the screw by using an Allen key.
2. Slide the handlebars to the correct height and tighten the screw very firmly again.

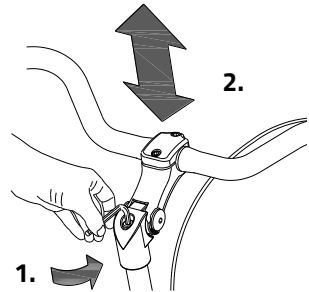

Do **not** pull out the handlebars **further** than the mark. Otherwise the tube will not be deep enough in the shaft and will risk coming off, which can lead to serious injuries.



## Position handlebars

You can tilt the handlebars. This influences the distance from the handlebar to the upper body. Determine your own most comfortable position by using the bike.

To tilt the handlebar:

1. Slightly loosen the screws [A] and [B] with an Allen key.
2. Put the handlebar in the desired position and then tighten the screws considerably.
3. Slightly loosen screw [C] with an Allen key, put the handlebar in the correct (horizontal) position and then tighten the screw again.

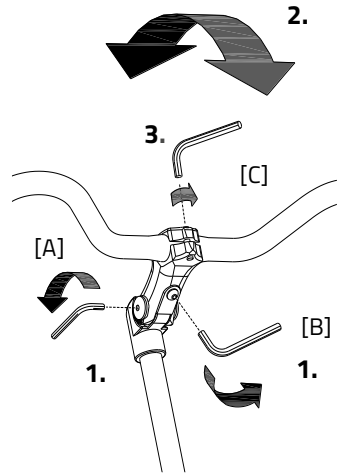

## Steering damper

The steering damper affects the stability during steering. By adjusting the screw, steering gets more rigid and stability will increase. Determine your own most comfortable setting for using the bike.

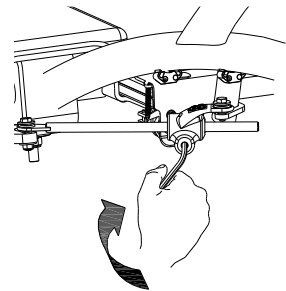

## Wheelchair transport

If you want to transport a wheelchair on the VeloPlus3, follow the instructions below.

1. Attach the parking brake to the bike by squeezing the left brake [A] and lock it with the pin [B].
2. Remove the safety pin.
3. Pull the handle up so the ramp unlocks and falls down.
4. Push the wheelchair backwards on the ramp. Push the wheelchair until the ramp is tilting and locks itself automatically with a clear noticeable click.
5. Attach the wheelchair with the three belts. Push the button to release the belt and attach the hooks to the wheelchair.

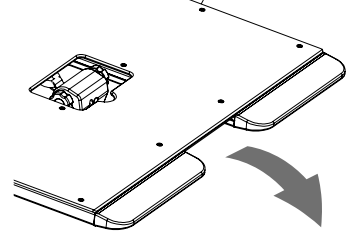
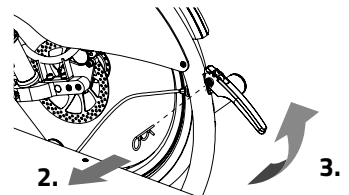
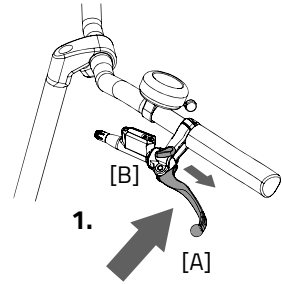

**Always** place the wheelchair forward, in the driving direction, on the ramp. (see image)



**Be sure** that the ramp is locking! Failing to do so may result in serious injuries. If the ramp does not lock properly then use your foot [A] to push until the ramp locks.

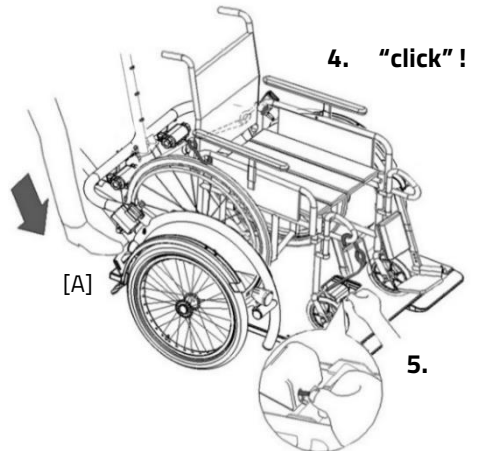



**Make sure** that once the wheelchair is placed on the ramp, the wheelchair's weight causes the ramp to fold up automatically. When that is the case, the centre of gravity of the wheelchair is situated above the front wheels of the bicycle. This creates the correct weight distribution of the bicycle.

6. Next, turn the star knob to tighten the belts.
7. Finally fasten the safety belt of the passenger.
8. Replace the safety pin in the coupling.

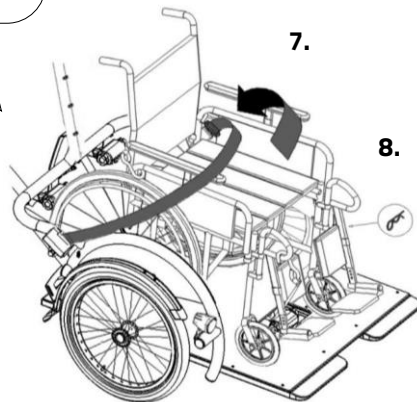
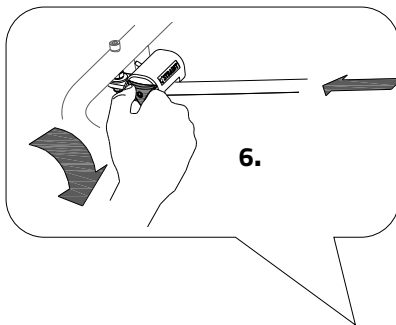

To remove the wheelchair from the bike, follow these steps in reverse order.



**Caution:** Stop the wheelchair when you release the hooks so that it will not roll off the ramp.

## Before the first use



### Remove foil

Remove the protective foil from the plate before using the bicycle.

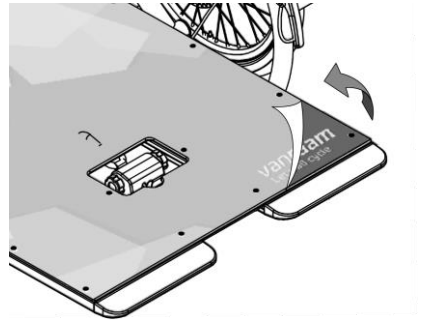

### Parking brake

Always use the parking brake if you park the tricycle and leave it behind.

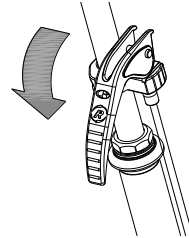

Block the tricycle with the hydro brake when passengers are getting on and off.

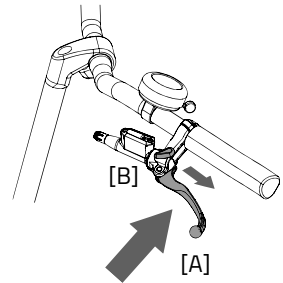

To operate the parking brake, squeeze the left brake [A] and secure the brake with the lever [B].



Always try to park the tricycle on a level surface. The tricycle may never be parked on a slope bigger than 6 degrees.

## Lighting

Normally, the lighting on your bike can be operated manually and set to different modes. However, if your bike is equipped with the Silent Elektro system, your lighting will automatically turn off when the electric system is activated. The controls of both the manually operated and centrally operated lighting is explained below.

### Manually operated headlight

The front light has a pressure switch with three settings: **On/Auto/Off**.

By pressing the pressure switch once, the front light will turn on. By pressing again the lamp will switch to 'Auto' mode (a green LED will flash for 5 minutes). Finally, a third press will turn the front light off.

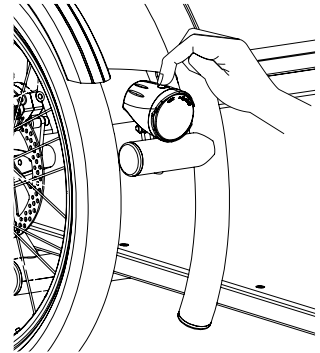

#### Auto "on" feature:

The front light will automatically turn (as long as it is in 'Auto' mode) on when it is dark, the light sensor is activated and the tricycle is in motion.

#### Auto "off" feature:

The front light will automatically turn off after 4.5 minutes without motion in 'Auto' mode. The light will first dim from 100% to 50% and then completely turn off.

Adjust the angle of the front light so that the centre of the light beam is located approximately ten metres in front of the tricycle.

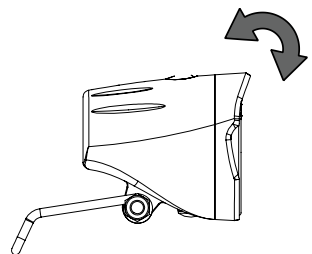

Under the pressure switch on the top of the front light is a battery indicator that lights up when the batteries are low. Once the battery indicator starts lighting up red, replace the batteries as soon as possible.

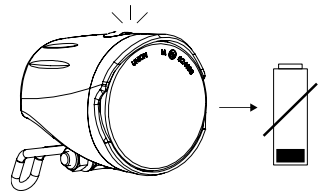

The light comes with 4 pre-installed AAA alkaline batteries. Before use, remove the plastic strip that protects the batteries.

Follows the steps below to replace the batteries.

1. Remove the screw on the bottom of the front light with a screwdriver.

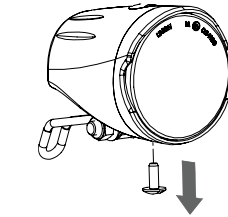

2. Remove the front cover by turning it slightly and pulling it forward.

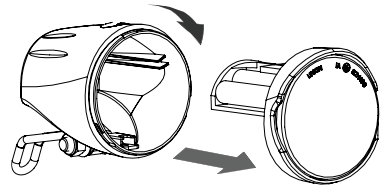

3. Replace the alkaline batteries (1.5 V - 1500 mA) and reattach the front cover.

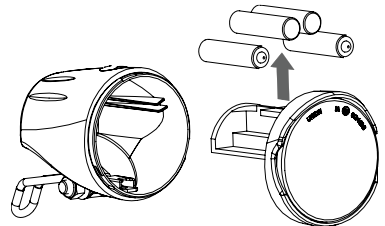

Only operate the lighting when the tricycle is stationary to prevent dangerous situations and risk of crushing. Advice: use the automatic function of the lighting.

## Manually operated rear light

The rear light has three options which you can choose by pressing the button repeatedly: **On-Auto-Off**.

The setting is as follows:

- Press **1x**: light is on
- Press **2x**: lighting is automatic
- Press **3x**: light is off

With the "On" or "Off" mode, the rear light can be manually switched on and off. With the "Automatic" mode the rear light automatically turns on and off with the help of light and movement sensors. When the tricycle stands still for a while, the light will automatically turn off.

The rear light works on batteries. When the batteries are almost empty, a red LED light on the top starts flashing. To replace the batteries, follow the next steps.

1. Dismantle the cover of the holder by pressing in the lip at the bottom of the light.
2. Replace the alkaline batteries (1,5 V – 1500 mA) and assemble the cover.



*Batteries cause environmental pollution.  
Follow the local regulations during disposal.*

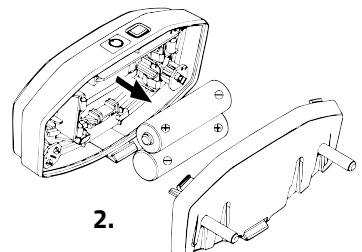
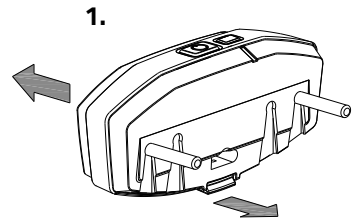
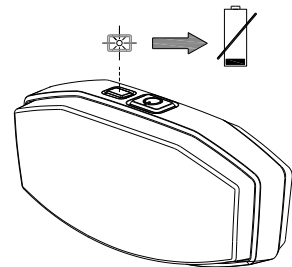
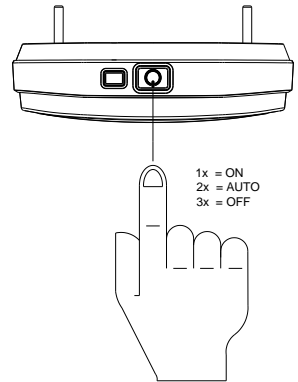



## Centrally Operated Lighting

The bike has been equipped with centrally operated lighting, with the lighting being connected to the electric system.

The lighting will turn on automatically when the electric system is activated.

Adjust the angle of the headlight, so that the centre of the light beam is aimed about ten metres in front of the bike.

You can manually turn the lighting on and off by briefly pushing the on/off button on the display. When the electric system is turned off, the lighting will turn off automatically.

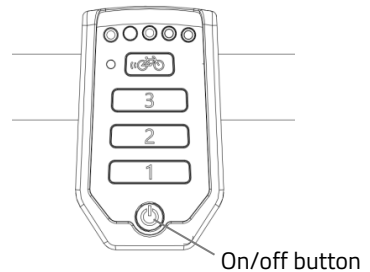
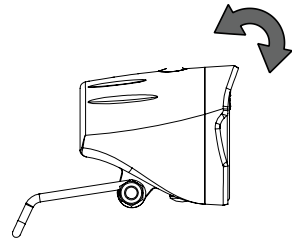

*Make sure there is always a battery on the bike when you are cycling after dark!*

Once the battery is nearly empty, the motor will no longer provide pedal support power assistance while cycling. The lighting will still be powered by leftover power.

## Gears

Your tricycle has eight gears. The gears can be adjusted by turning the handle. **Never pedal** when changing gears.

**Please note:** If your bike has an electric motor at the rear, you must **continue pedalling** when changing gears.

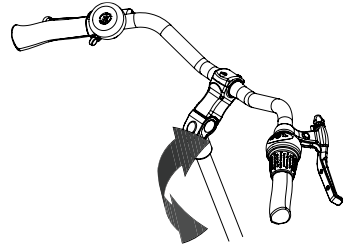

**Please note!** Do not shift gears and then paddle backwards. This could cause the chain to run off the sprocket.

### Check before every ride:

- The brakes (including the parking brakes)
- The tyre pressure (recommended: 3 bar)
- The lights
- That all parts are fitted properly
- That the battery is adequately charged (depends on options)

Contact your dealer and stop using your tricycle as soon as you observe irregularities during the check!

As with all mechanical parts, the tricycle is subject to wear tear and high loading. If a component fails, it can lead to very dangerous situations. This can lead to damage or injuries to the user of the tricycle. Any form of cracks, scratching or change in colour in heavily loaded parts or a component indicates that the component must be replaced.

### Points of interest during cycling

After you have adjusted the tricycle to the measurements of the cyclist, you can start using the bike.



The tricycle gives a very different ride experience than a bicycle!

Practice, in particular, with bends and braking, because a tricycle can react contrary to what you would expect. It may happen that the back wheel comes off the ground on the inside when going round a bend. To avoid this, the rider leans towards the inside of the bend with his body.

One of the brake levers (usually the right) operates the brake on the front wheel. This deserves special caution, as a forceful braking could block the front wheel, which could result in a fall. The driver should be familiar with controlled braking of the front wheel!



If there is an electric motor on a bike: you must train with the acceleration function and reverse functions. Be careful that the acceleration mode or reverse mode are not unintentionally started while using the bike. For example, at traffic lights the reverse function can accidentally be activated and the tricycle reverses.



High speeds in the bends, driving on rough ground, and sharp bends can lead to the tricycle **falling over!**



The tricycle will behave differently when cycling without a passenger. Try this very carefully the first time!

### Important safety points for the cyclist

- Be very careful during the first ride.
- When riding the tricycle hold both hands firmly on the handlebars and feet on the pedals.
- Test the riding style of the tricycle on rough ground at moderate speed. This way the cyclist learns how to react to unexpected movements of the tricycle and the handlebars during use.
- Explore how the tilting movements of the tricycle react to body posture. Tilt to the inside of the bend.
- Small obstacles should be cycled over with appropriate speed.

- Obstacles higher than five centimetres should be avoided.
- Ensure that no dangerous speed develops while driving downhill and entering tunnels. Brake on time and cycle at a moderate speed.

## Electro system Silent

The Silent Electric motor system is a special developed support system by Van Raam for the rehabilitation market. The system is characterized by:

1. A simplicity of operation
2. Individually adjustable support for cycling
3. Modern and efficient electronics
4. The powerful electric motors
5. High quality and safe batteries
6. Highly reliable system

The Silent system comes standard with a basic support mode individually programmed for your bike. In most cases, it gives precise and smooth cycling characteristics with a good compromise between support and radius of action.

In special cases, an individually tailor-made cycling program is necessary. You can obtain information from the dealer about the possibilities of a customised cycling program.

### Functions:

The electric system has the following functions:

- Pedal support while cycling
- Start support
- Backwards pedalling with support
- Intergrated lighting control

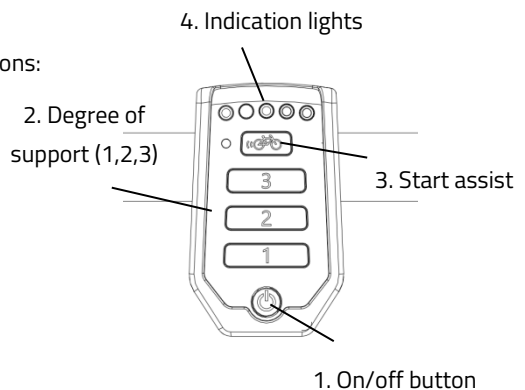

## 1. On/off button

Using the on/off button, the electrical system can be switched on or off.

- Switching on: Push the button briefly.
- Switching off: Push the button for two seconds.

After the system is turned on, the electric motor is active in level 1.



*When the system is not used, it will automatically turn off after a certain time.*



Always turn off the electric system before getting on and off the bike, and when you are walking while holding the bike.



Make sure that the switch under the luggage carrier is always pressed toward the side where the battery is located. Note that with some models the battery switch has a middle (neutral) position as well. That means the battery is switched off.

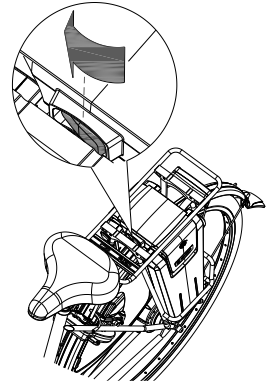

## 2. Degree of support 1, 2 and 3

The desired support can be set by using one of the support levels 1, 2 or 3.

1. Light support, maximum range.
2. Average support, average range.
3. Maximum support, low range.

You can change the level while cycling.



*The behaviour of the battery depends on a lot of different factors and is strongly influenced by: capacity and voltage of the battery, degree of support that is used, temperature, wind speed, tyre pressure, cycling speed, weight of the user and the luggage, use of gearing etcetera.*

### **3. Start assist**

The Silent electric motor has a start support. This allows the driver to pull-away without pedalling up to a speed of 6 km/h over 6 seconds. To accelerate, press the start assist button and keep it pressed down. The function will only activate again, when the support button has been pressed down again. If you peddle normally, the function works for up to 6 seconds, each time the button is pressed, up to maximum speed of the tricycle (20 km/h).

The start assist is used for:

- Extra support when starting.
- Extra support for cycling uphill.



*When cycling a steep climb, you can use support in level 3 and push the start assist repeatedly for 6 seconds to achieve maximum support.*

## 4. Indication lights

The level of charge in the battery is given by five LED lights: four of these are green, the one on the left can show either green or red, if charge is low.



The battery is fully charged. When in use, the number of green LED lights on the battery will decrease.



The battery is 50% charged when two green LED lights are on.



The battery is almost empty if only the last red LED light is on. The battery needs to be recharged or replaced by a (new) fully charged battery.



When the last red LED light flashes, the battery is empty and the motor will no longer support while cycling. The integrated lighting continues to work.

The battery is equipped with a button and indicator that makes it possible to check the charge by briefly pressing the button [A]. The status of the battery is shown with five green indicator LEDs, of which the left most one can blink. That means the battery is nearly empty. During charging, the battery displays the progress of the charging.

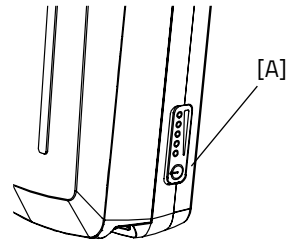

### Reverse mode

The reverse mode is activated by pedaling backwards from a standing position. Within a few seconds the motor is activated and the tricycle cycles at a speed of about 2 km/h backwards (when you start to pedal backwards).



Do not be startled by an unexpected reaction from the electrical system. If you e.g. wait for the traffic light and you play with the pedals by moving them backwards the reverse mode is activated and the tricycle cycles backwards.

## Centrally Operated Lighting

The bike is equipped with centrally operated lighting, with the lighting automatically turning on when the electric system is activated. Further instructions can be found in the chapter '**Before the first use**'.

## Other functions

The smart display has an automatic dimming function. With an inbuilt light sensor the lights of the display will automatically creating less distraction for the cyclist in darker or more shadowy conditions.

## Charging the Battery

For the best performance and to prolong the life of the battery, we recommend that you charge the battery at home at room temperature.



Use the charger only when the ambient temperature is between 0 and 35 degrees.

To charge the battery:

1. Unlock the battery by turning the key a quarter.
2. Pull the handle forward.
3. Take the battery pack from the holder.
4. Take the battery pack inside. **First** plug the charger into the socket. The green LED will light up. The charger is now on standby.

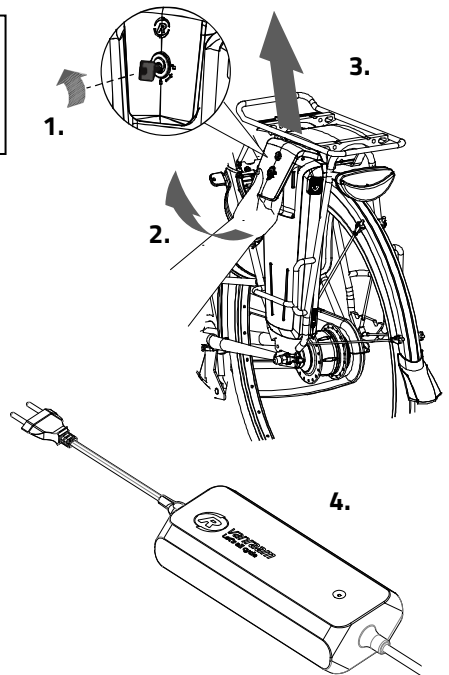



5. **Then** insert the connector of the charger into the charging point of the battery. The red LED will light up. The charger is now charging.



**Please note!** If the battery is not connected properly, the green LED will light up (standby mode). If the connection is poor, unplug the plug from the socket and clean the charger's connector with a dry cloth.

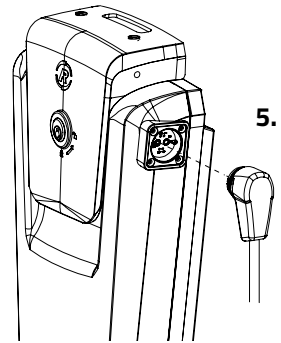

6. Depending on the battery level, the charging time is about 2,5 hours with a 13,6 Ah/36 V battery.
7. Once the battery is fully charged, the green LED will be solid. Now **first** remove the charging connector of the charger from the connector of the battery.
8. **Then** unplug the charger from the socket.
9. Put the battery back in the holder of the cycle. Slide it behind bar [A] and press it firmly on strip [B].

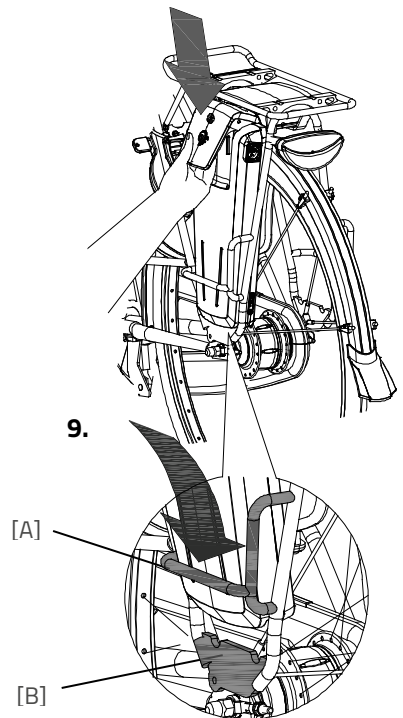

10. Pull the handle backwards and push the top of the battery to connect as shown in the drawing and close the lock.
11. Push the handle forward and close the lock.

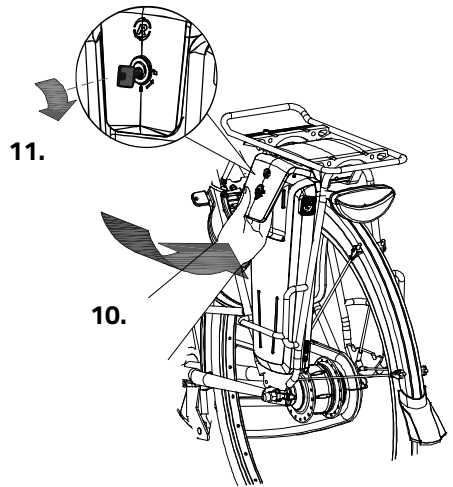

It is also possible to charge the battery while it is still in the holder.

Charger:

LED indication	Status
Green	Standby
Red	Charging
Green	Battery full
Red, blinking	Safety: Polarity inversion; Short; Over temperature; Over power; Over voltage



It is better for the battery if it is charged regularly, rather than wait until it is completely drained. Never leave the bike with a drained battery!

## Backup battery (optional)

The bike can be supplied with a second battery.

To activate the second battery (when the first battery is empty) turn the switch under the luggage carrier to the side of the second battery.

## Battery Deep Sleep Mode

When the battery is nearly empty and has not been used for a week, the battery will enter deep sleep mode. In this mode the battery uses as little power as possible, to increase the lifespan of the battery.

When the battery is in deep sleep mode, it cannot be used. By pressing the button on the battery, the battery will be woken up from deep sleep mode, and it can be used again. It is recommended to first charge the battery before using it in that scenario.

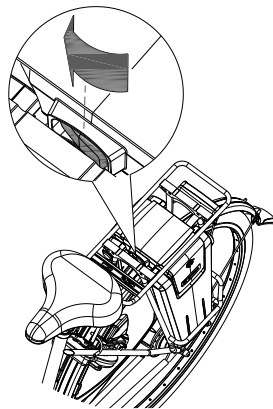

## Charging and maintenance tips for the battery

- Never leave the bike with an empty battery! We advise you charge the battery as soon as possible before it's totally empty.
- The best storage-charge of the battery is when three to five LED lights are lit.
- Check the battery every month in the winter. If fewer than three LED lights burn, recharge the battery.
- Preferably store and use the battery in environments of 5 to 20 °C. Avoid higher or lower temperatures.
- Do not charge the battery in sunlight and make sure that the battery is not charged at a temperature of less than 5 °C.
- Only use the charger indoors and in non-humid environments, the charger should *not* get wet.
- Only use the Van Raam supplied battery.
- Only charge the battery with the supplied charger!
- The battery housing and charger housing may never be opened! When there is a problem, contact your dealer.
- The Van Raam battery may not be revised due to serious safety risks and the incorrect functioning of the electric system as a whole.

- Don't drop the battery, this can cause external and internal damage.
- If your bicycle has a fault, the battery should be disconnected from the bicycle.



*Keep in mind that your bike provides less support when it's cold (0°C and less) and the battery will discharge faster. Charging also takes more time at lower temperatures.*



*Every battery discharges automatically over time. This process is called self-discharge. A battery that is empty and not charged, will self-discharge and will be deep discharged. The battery can be permanently damaged during this process. In case of deep discharge, the warranty will be void.*



*Please note that any battery will wear over time. The wearing process of the battery is inevitable and depends on several factors, such as usage, number of charge cycles and the ambient temperature. Even if the battery is not used, its capacity will decrease. A worn battery can still be used, but please bear in mind that its charge level may decrease.*

### **Possible malfunctions**

- The system does not turn on:
  1. Make sure that the battery is properly attached.
  2. Check if the switch under the luggage carrier is pressed towards the side of the battery.
  3. Check the status of the battery. If it is empty, recharge the battery.
  4. If the above action does not help, contact your dealer.
- If the battery indicator LED lights on the display are flashing:  
The motor may be overheated by continuous high load. For protection, the system will reduce the support.
  1. The system is in temperature-protection. You can continue cycling with reduced support.
  2. After cooling down, the normal support and indication will restore automatically.
- If the support LED lights on the display are flashing:  
This indicates motor failure. You will need to contact your dealer.

- If a red LED light on the charger starts flashing, remove the plug from the mains outlet and do not longer use the charger. In this case, contact your dealer.

## Charger Safety Measures

- Only charge Van Raam Li-Ion batteries with the included charger. Only connect the charger to a suitable power point (220-240 Volt AC 50-60 Hz). If the charger is not being used, unplug it from the socket and take the plug out of the battery.
- The charger may only be used by people who have read the information in this user manual and are familiar with the proper use of the charger. Keep the charger out of reach of children; do not let them play with it.
- The charger has been designed for use in a dust-free, dry, and ventilated environment. Do not expose the charger to water, heat sources, and direct sunlight. Keep the charger clean and dry.
- Do not charge batteries that feel hot to the touch. The battery may not be hotter than room temperature for charging. Stop charging if the battery becomes abnormally hot ( $>40^{\circ}\text{C}$ ).

**Please note!** The charger may become hot during charging  $> 50^{\circ}\text{C}$ . First carefully feel if it is safe to touch the charger. This temperature can cause sensitivity or startle if it comes into contact with the skin.

- Do not use the charger if it is visibly damaged or modified. Do not repair the charger! Please contact Van Raam. Never open the charger yourself!
- While charging, please monitor the charger and the battery. Once the battery is full, remove the plug from the socket and the plug out of the battery.

## Van Raam e-bike app

The Van Raam bicycle app is a free smartphone app that you can use while cycling on your electric Van Raam bicycle.

### What can you do with the Van Raam e-bike app?

It depends on the type of battery you have; a battery without a yellow GPS sticker or a battery with a yellow GPS sticker.

#### I have a battery without a yellow GPS sticker

- App can be used as a luxury bicycle computer
- Change bike settings
- Send SOS messages with GPS location to a number of your choice
- View cycled routes
- View information about the bike

#### I have a battery with a yellow GPS sticker

If you have a battery with yellow GPS sticker, then the above functions are also possible. In addition, some functions are added, namely:

- Pairing battery
- View battery data
- Receive battery advice
- Receive push notifications

#### How does the Van Raam e-bike app work?

With the Van Raam e-bike app, a connection can be made with the display via Bluetooth connection. As soon as the display is ready to connect to the smartphone, the on/off button will briefly turn blue.



This app can be used as a luxury bicycle computer for Van Raam bicycles with pedal assistance and also contains many other extra functionalities. The dashboard on the app shows the current speed, total distance, trip meter, battery capacity and power consumption during the bike ride. For more cycling data, there is a details screen including average speed, maximum speed, total distance, power, battery voltage, pedaling power and pedaling frequency.

The Van Raam e-bike app can be downloaded free of charge from the **Google Play Store** or **Apple App Store**.

For more information about the Van Raam e-bike app, you can visit the Van Raam website: [www.vanraam.com](http://www.vanraam.com).

## Accessories

Depending on your order, you can use the accessories as described below. Extra accessories are available at your dealer.

### Dividable frame

The ramp can be disconnected from the bike, which can be convenient if, for example, you want to store the bike.

To disconnect the ramp:

1. Use the parking brake by pressing the left brake [A] and securing the brake with the pin [B].
2. Remove the right handle (with gears) from the handlebar. Press the spring's small sphere to remove the handle from the handlebars. Also remove the parking brake from the steerer tube by lifting it straight up from the holder (this can take some strength).
3. Hang the grip together with the brake handle on the luggage rack or other suitable parts.
4. Lower the support. By loosening knob [A], push down support [B] with your hand or foot and then fasten the knob again.

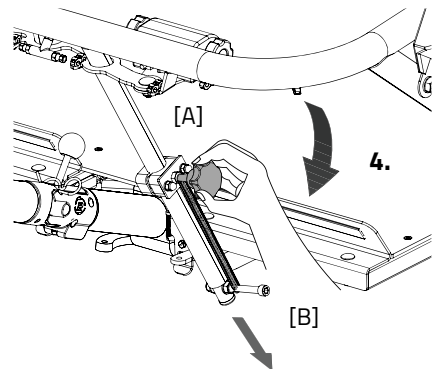
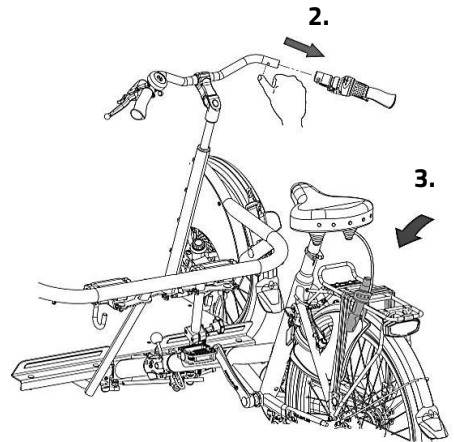
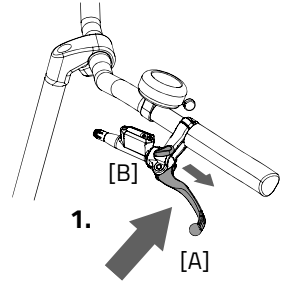



5. Remove the safety pin.
6. Hold the rear part (tricycle part) with one hand and then use your other hand to pull the lever backwards [A], allowing the tricycle to detach.

The wheelchair element will now stand on the support wheel.

7. Remove the bike apart from the coupling.

**Caution:** this is heavy! Hold the frame firmly in both hands.

8. Place the bike on the stand.

To reassemble the bike, follow these steps in reverse order.

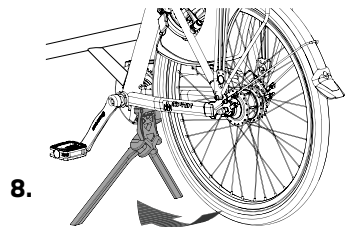
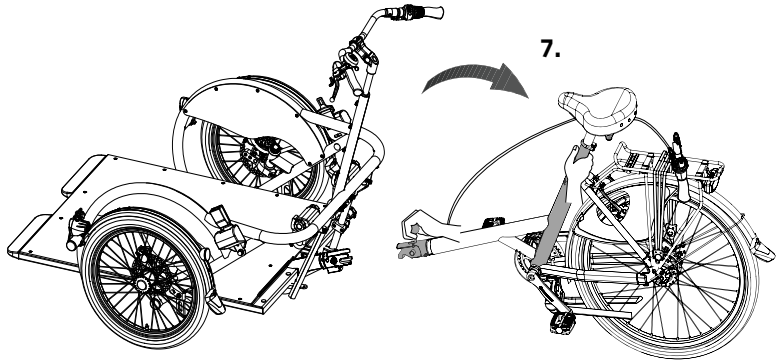
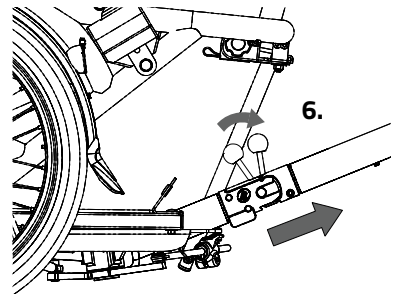
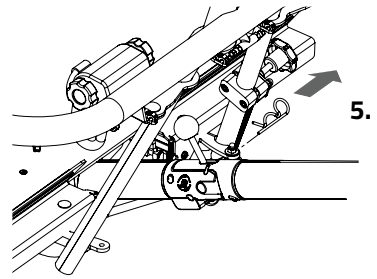

## Winch system

It is possible to place the wheelchair on the bike with the help of a winch.

To use the winch system:

1. Switch on the electrical system. Make sure that the light on the control panel is on. If this is not the case, you can switch on the winch system by briefly pressing the on/off button on the display of the electrical system.
2. Put the bicycle on the parking brake by squeezing the left brake [A] and securing it with the lever [B].
3. Remove the safety pin.
4. Pull the handle upwards so that the ramp unlocks and falls down.

1. Light

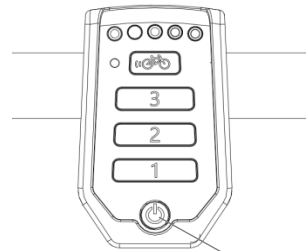

On/Off Button

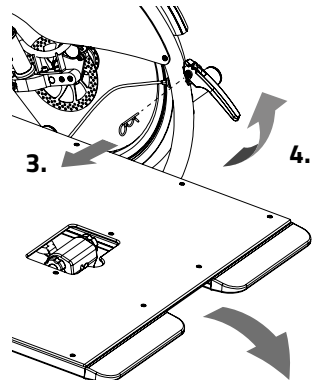
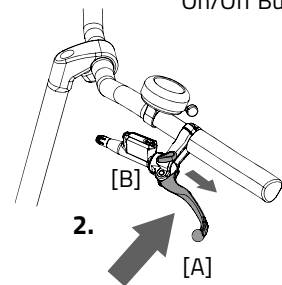

- Use the control panel on the bicycle or the remote control to unwind the winch. Press and hold the button and at the same time guide the winch so that it unwinds correctly.

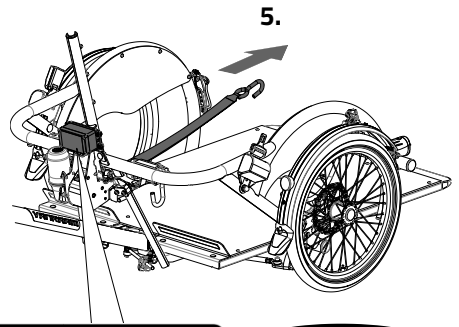

**Attention!** Do not roll out the winch beyond the **red line** on the belt, otherwise the belt will roll back on incorrectly.

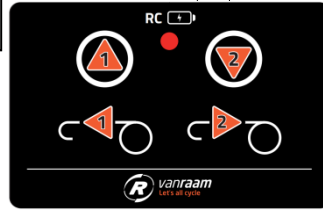

Control panel on bike

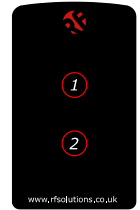

Remote control

- Place the wheelchair **straight** in front of the ramp and secure the hook to the wheelchair.



**Attention!** Place the hook as close to the ground and in the middle of the wheelchair as possible to prevent the wheelchair from tilting and twisting.

- Use the control panel to rewind the winch. Hold down the button and at the same time guide the wheelchair so that it is positioned straight onto the ramp.
- Pull the wheelchair onto the ramp until the ramp tilts and locks automatically and you hear an audible click.

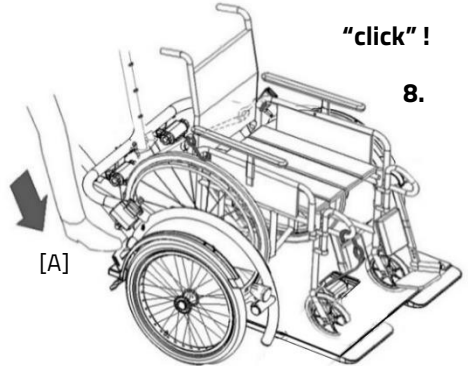



**Attention!** Make sure that the ramp locks into place! Otherwise very dangerous situations may arise. If the ramp does not engage, press with the foot [A] so that the ramp engages.



Make sure that as soon as the wheelchair is placed on the ramp, the weight of the wheelchair automatically causes the ramp to fold up. At this moment the centre of gravity of the wheelchair lies above the front wheels of the bicycle. This ensures the correct weight distribution of the bicycle.



Only place the wheelchair forwards, in the direction of travel, on the ramp. (see picture)



The winch hook is not meant to fix the wheelchair on the bike.

9. To further secure the wheelchair, follow the steps described under the heading 'setting up the bicycle - wheelchair transport'.

To remove the wheelchair from the bicycle, follow these steps in reverse order.



Hold the wheelchair when you release the hooks so that the wheelchair does not drift off the ramp.

The control panel on the bike and the remote control are interconnected. When the battery light on the control panel is on continuously, the winch system is activated and the remote control (Remote Control, RC) is charged. When it starts flashing, the battery of the remote control is almost empty and needs to be replaced.

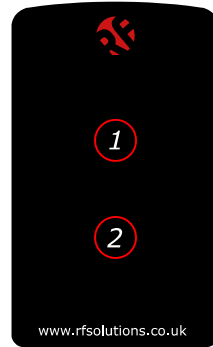
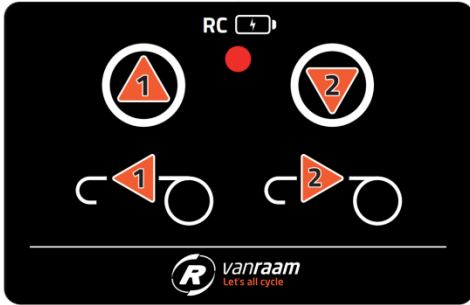

Follow the next steps to replace the remote-control battery.

1. Remove the cover on the back by unscrewing the two screws.
2. Replace the battery (CR2032, 3V), note position +/-, and mount the cover.



*Batteries are polluting to the environment. When disposing of batteries, follow local regulations.*

#### Remote control

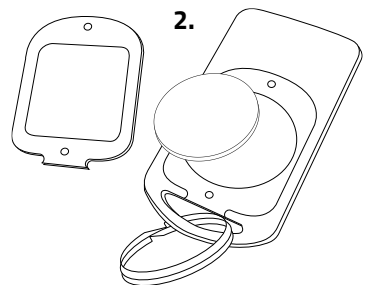
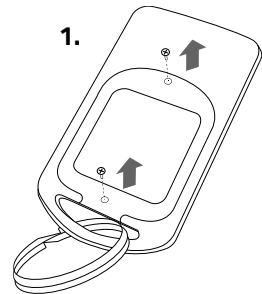

## Technical specifications

Length (cm)	253
Width (cm)	110
Height (cm)	114
Boarding height (cm)	28
Length of inner leg (cm)	80 - 95
Front wheel	20"
Back wheel	26"
Weight (kg)	approx 64
Max. load luggage rack (kg)	20
Max. weight rider (kg)	110
Max. weight passenger incl. wheelchair (kg)	140 <sup>1</sup> , 200
Brakes, front	Disc brakes
Brakes, back	Cantilever brakes

<sup>1</sup> Standard

## Maintenance and adjustments to be done by owner

Below you can find the instructions for maintenance and adjustments that you can do yourself on a regular basis, which will keep your tricycle in top condition.

### Cleaning

The frame of the tricycle can be cleaned with a damp cloth. For areas that are dirtier you can use a mild detergent.

The wheels can be cleaned with a moist brush with plastic hairs (not a wire brush!). The saddle and the grips can be cleaned with mild soap and water.



Do not use a pressure washer or a steam cleaner!

### The right lubricant

The chain should be cleaned and maintained at regular intervals (every three months approximately). Only use special chain grease or Tevlon spray. This is the only way to make sure that the chain will run smoothly, will stay water resistant and will not rust.

1. Wipe the chain with a cloth.
2. Treat it with grease or spray.
3. Remove any excess lubricant with a rag.

Other parts should **not** be treated with a lubricant.

### Inspection of the tricycle

It is recommended that the tricycle has a yearly inspection carried out by the dealer to claim warranty. Please use the form "Form service, maintenance, modifications and warranty claims" in the back of this manual. After 200 kilometres or after a period of two months the tricycle should be inspected.

In the event of technical trouble or faults, the tricycle should be taken to the dealer for repairs **immediately**.

The replacing of safety-related components (especially frame, brakes, lighting, handlebars, front fork and actuation) should be performed by the dealer.

If you still decide you want to replace components yourself, you are responsible for damage or harm due to incorrectly fitted components.

Only use **original** Van Raam spare parts, which you can buy at you dealer. If requested the dealer will make the necessary information on repair and maintenance available.

## **Repairs and maintenance to be done by dealer**

Check the brakes, the rims, lighting, the chain tension and the spokes. Also checks the tyre tread depth. This should be at least one millimetre. Worn out tyres or possible faulty parts should be replaced. Also check the parking brake. With the parking brake pulled up, the tricycle should not ride away with the cyclist.

### **Checking the rim**

Due to the combined action of the brake and the rims, not only the brake lining but also the condition of the rim is important. For this reason the rim should be checked at regular intervals, for example when you inflate the tyres. The presence of fine cracks in the spoke punches or deformation of the rim when there is higher air pressure indicate more serious wear and tear. In that case the rim should be replaced, because it can lead to loss of brake function or even a crack in the rim, which can lead to all kinds of dangerous consequences.

Repairs, maintenance and modifications should only be performed with original Van Raam parts.



## Adjustments by dealer

### The correct tension of the chains

Several chains are present on the tricycle. These must have enough room for movement. Without any real effort, the chain must be able to be moved about half a centimetre up and down.

In order to keep tension on the chain, the rear wheel axis can be adjusted. Follow the instructions below:

1. Slightly loosen the nuts on the rear wheel axis, allowing the rear wheel to move back and forth.
2. Tighten the screws on the two chain tensioners, making the rear wheel move backwards and tightening the chain. Do this in such a way that the chain has some room to move, as previously indicated.
3. At the same time, make sure the wheel is straight and located in the middle of the frame. Not to the left or right. See figure [A].
4. Lightly tighten the nuts of the rear wheel axis.
5. Make sure the tension on the chain is adequate and that the wheel is attached straight to the frame.
6. Now firmly tighten the nuts.

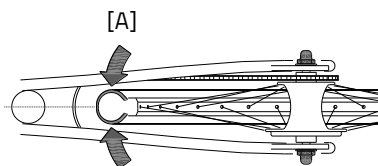
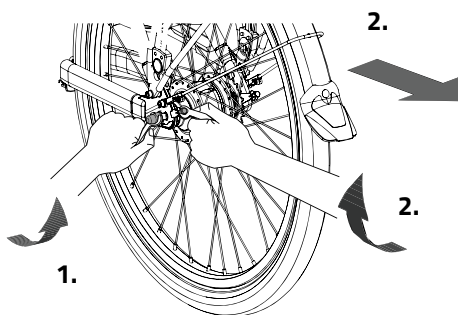

## **Disposal**

If you want to dispose your tricycle, contact your dealer. You can also contact the local waste disposal company. They will dispose the tricycle according to the regulations of your town.

## **Recycling the Battery**

If your battery is defective or if you are no longer using it, you must have it recycled. Please contact your dealer. They are responsible for complying with the recycling obligation. Ask them about the conditions or view the rules regarding recycling in your place of residence/country.

## **Handover/sale to a new owner**

When you hand over your tricycle to a new owner it is important that you also hand over all necessary technical documentation and spare keys, so that the new owner can use the tricycle safely.

## Guarantee

The guarantee is valid for all faults in the product, which are proven to be caused by material or manufacturing error.

We give a guarantee of five years on the frame and the front fork. For all accessories and other parts (except wear parts) we provide a two year guarantee, as legally regulated. The guarantee only applies for normal use and maintenance of the tricycle, as described in this manual.

### **Beware!**

The guarantee as well as the product liability in general expires if the instructions stated in this manual are not followed. This is also the case if unauthorized maintenance is carried out or if technical changes or additions are made with non-original Van Raam parts without permission of Van Raam. The original CE certification will become nul-and-void if modifications are done by third parties. The absence of the certification can lead to problems in insuring your bike, and for any loss or incurred.

## Frame number

The frame number is printed on the sticker. This sticker is located on the frame, see the image below.

Example sticker:



Position of sticker:



Behind the seat tube

## Maintenance recommendation

A Van Raam bike often is subject to extensive use and must perform in all weather conditions. By correctly maintaining the bike, the lifecycle can be extended greatly. This maintenance can be done by a Van Raam dealer. In most cases, you can do the monthly and annual inspection yourself.

### Maintenance Overview:

What	One-person bike	Multi-person bike	Duration	By whom?
1 <sup>st</sup> service moment	3 months/300 km	3 months/200 km	15 min	Dealer
2 <sup>nd</sup> Service moment	6 months/1.000 km	6 months/500 km	15-30 min	Dealer
3 <sup>rd</sup> Service moment	12 months/2.000 km	12 months/1.000 km	30-90 min	Dealer
Monthly inspection*	Every month	Every month	15 min	User
Annual inspection*	Every 12 months	Every 12 months	60 min	User

\* This is advised to extend your bike's lifecycle. You can also have this done by your dealer.

#### Monthly inspection

15 minutes

Among them:

- Check and inflate the tyres
- Check the chain tension and grease if needed
- Tighten bolts/nuts where needed
- Check all lights
- Check the brakes
- Check all rotating parts and grease if needed
- Clean the bike

#### Annual inspection

60 minutes

Among them:

- Check and touch up the paintwork
- Check the wheels for any buckling
- Check the spoke tension
- Check the steering ball joints
- Check all lights
- Check the saddle clamp
- Check the placement of all electric components (E-Bikes only)

### **1<sup>st</sup> Service moment**

15-30 minutes

Among them:

- Check tyres and inflate
- Check the spoke tension
- Check the chain tension and grease
- Tighten any bolts and nuts if needed
- Check all brake cables and brake calipers
- Check the gears
- Check and grease all rotating parts
- Check all lights
- Clean the bike

### **2<sup>nd</sup> Service moment**

30-90 minutes

Among them: All points from service moment 1, and:

- Inspection of the pedals and bottom bracket
- Grease and tighten the lock
- Grease and tighten the steering stem
- Check the steering ball joints
- Run all tests in the dealer tool (E-Bike)

### **3<sup>rd</sup> Service moment**

60-120 minutes

Among them: All points from service moment 1, 2, and:

- Inspection of the paintwork
- Inspection of the frame/front fork
- Inspection of the seat cushions
- Inspect the functioning and sound of the motor/gear hub
- check reflectors for any damage
- Check all electric components on their placement (E-Bike)
- Run all tests in the dealer tool (E-Bike)

## Service plan

### 1<sup>st</sup> Service moment

- Yes/No
- Dealer:
- Mechanic:

Date:

Remarks:

.....

.....

.....

.....

### 2<sup>nd</sup> Service moment

- Yes/No
- Dealer:
- Mechanic:

Date:

Remarks:

.....

.....

.....

.....

### 3<sup>rd</sup> Service moment

- Yes/No
- Dealer:
- Mechanic:

Date:

Remarks:

.....

.....

.....

.....

## Annual inspection

Date	Dealer	Mechanic	Remarks







## Delivery and service form

Congratulations on your purchase of your Van Raam tricycle. This bike is produced with utmost care. To guarantee the quality as much as possible Van Raam produces the cycles according to the ISO 9001:2015 quality standards. Van Raam has been certified by DNV GL Business Assurance BV.

You will especially enjoy your Van Raam bike when the bike is adjusted to your specifications and when the instructions in the user manual are followed. Pay special attention on the service intervals who specified in the manual of the bike.

To claim warranty and service you should always fill out this form, at least at delivery and service. This signed form declares that the end user had an instruction on the operation of the tricycle, that the tricycle is adjusted to the specifications of the end user and that the user manual is received.

### Fill out when the tricycle is delivered

Type Van Raam tricycle:	
Frame number:	
Key number:	
Delivered to:	
By dealer:	
Place:	
Date:	
Signature user bike:	Signature dealer:
When available, stamp dealer:	